



OPERATION MANUAL

**SEQUENTIAL
CIRCUITS INC**

MODEL 100
S/N 1 and up

**PRO-ONE SYNTHESIZER
OPERATION MANUAL**

by Stanley Jungleib

Sequential Circuits, Inc.
3051 North 1st Street
San Jose, CA 95134

(408) 946-5240

About the Pro-One

The Pro-One is a monophonic (one-voice) keyboard synthesizer. Its principal sound sources are two voltage-controlled oscillators (VCOs), referred to as OSC A and OSC B. OSC A, OSC B, and a white noise source can be mixed into the resonant low-pass filter (VCF). The filter modifies the voice timbre under control of its four-stage envelope generator. The filter may also serve as a sound source. This stage is followed by a voltage-controlled amplifier (VCA), which shapes the voice amplitude also under control of a four-stage envelope generator. The keyboard provides frequency control voltage (KYBD CV) for the oscillators and filter, and generates a GATE which controls the envelope generators.

In addition to this basic voice, the Pro-One has extensive modulation provisions. Three modulation sources are available: the filter envelope generator (FILT ENV), OSC B, and a separate low-frequency oscillator (LFO). Each can be mixed and routed for either DIRECT or WHEEL-controlled modulation of five destinations: OSC A frequency (FREQ), OSC A pulse-width (PW), OSC B FREQ, OSC B PW, and filter frequency (FILTER).

This complement of analog synthesizer modules and the routings provided for their interconnection have been well-proven in the Pro-One's ancestors, the Prophet-5 and Prophet-10 polyphonic synthesizers. Besides allowing the synthesist to play up to five or ten notes at one time, these two instruments contain microcomputers which program all the control settings comprising a sound. The Pro-One is neither preset nor programmable: you always "patch" the precise sound you want with the knobs and switches on the control panel. But the Pro-One voice itself is identical to a single Prophet voice, so it is capable of as much range and expression.

Possessing the Prophet's sound and all standard monophonic synthesizer features, the Pro-One's own microcomputer makes possible innovations unheard of on a low-cost synthesizer; a 40-note sequencer, an arpeggiator, keyboard modes such as single- or multiple- triggering, and the unique automatic glide feature. An audio input with preamplifier and automatic GATE generator allows synthesizer processing of low-level inputs such as a microphone or electric guitar. The audio output can drive a monophonic or stereo amplifier, or stereo headphones. Of special interest to computer enthusiasts, the Pro-One readily interfaces for control by an external microcomputer.

This manual contains all the information you'll need to fully enjoy this outstanding instrument.

Table of Contents

About the Pro-One	3
SECTION 1 BASIC OPERATION	
1-0 INTRODUCTION	6
1-1 CONNECTIONS	6
1-2 PLAYING	8
1-3 KEYBOARD CONTROLS	9
1-4 MODE	10
1-5 ARPEGGIATE	10
1-6 SEQUENCER	11
1-7 IN CASE OF DIFFICULTY	12
SECTION 2 FRONT PANEL	
2-0 INTRODUCTION	13
2-1 THE VOICE	13
2-2 OSCILLATOR A	15
2-3 OSCILLATOR B	16
2-4 GLIDE	17
2-5 MIXER	17
2-6 FILTER	18
2-7 AMPLIFIER	20
2-8 MODULATION	20
SECTION 3 BACK PANEL	
3-0 INTRODUCTION	23
3-1 AUDIO IN	23
3-2 FILTER CV IN	23
3-3 GATE OUT	24
3-4 CV OUT	24
3-5 GATE/CLK IN	24
3-6 CV IN	24

SECTION 4 ROUTINE MAINTENANCE

4-0	INTRODUCTION	25
4-1	CLEANING	25
4-2	USER TRIM	25
4-3	OPENING	28
4-4	FUSE	28

SECTION 5 SERVICE

5-0	INTRODUCTION	29
5-1	REMOVING PCB	29
5-2	DAC SCALE	29
5-3	TUNING	30
5-4	AMPLIFIER BALANCE	33
5-5	KEY CONTACTS	33
5-6	DIGITAL INTERFACE	34
5-7	AUTHORIZED SERVICE CENTERS	35

SECTION 6 SELECTED BIBLIOGRAPHY

SECTION 7 FACTORY PATCHES

SECTION 8 PANEL BLANKS

SECTION 1

BASIC OPERATION

1-0 INTRODUCTION

This section contains instructions for Pro-One set-up and basic operation. After unpacking, read paragraph 1-1 and connect the instrument as described. To quickly learn how to use the Pro-One, read also paragraph 1-2. This explains use of the factory-provided patch diagrams (Section 7). Additional performance information on the keyboard modes, triggering, the arpeggiator, and the sequencer follows (paragraphs 1-3 through 1-6).

The Pro-One synthesizer offers extraordinary capabilities for spontaneous control of pitch, timbre, and loudness. To exploit these capabilities fully, learn as much as you can about it with this manual and the books listed in Section 6. Additional references can be obtained from the more extensive bibliographies contained in the sources listed. Thus prepared, you will no doubt create many interesting sounds. Be advised that the best patches tend to disappear if not documented. Panel blanks for this purpose are provided at the back of this manual.

Remember the Pro-One is a sophisticated instrument. It should be handled with as much care as you would give a violin. Shock or vibration can damage the keyboard, wheels, knobs, and can loosen socketed integrated circuits (ICs). If you expect to transport the Pro-One regularly, we recommend that you invest in a professional "flight" case for it. These are made by several manufacturers and should be carried by your music dealer. If you can't find a case, please contact our Sales Department.

1-1 CONNECTIONS

The Pro-One has a switch on its back panel for selecting between a 115- or 230-Vac power source. Pro-Ones shipped in the U.S. and to Japan are usually switched to 115V, and those destined for Europe are usually switched to 230V. WARNING: Check this switch and set to match your line voltage before plugging the instrument in. Don't change this switch when the line cord is connected. If you do switch the line voltage selector, you will have to change the fuse also. For directions, see paragraph 4-4.

As with most electronic equipment, the Pro-One comes with a three-prong power plug to insure safe grounding with other equipment. The ground prong is connected directly to the metal chassis. It is up to you to check the power and ground interconnections of the Pro-One and all other instruments and equipment you use to prevent potentially lethal shocks. As you probably know, many older buildings and clubs are notorious for their poor quality AC wiring. We therefore urge you to use one of the several "ground-checking" devices available on the market to verify AC connections.

Because of the AC ground, a "ground loop" will often be created when the audio cable is connected between the Pro-One and its amplifier. As a result, low-level hum may occur. Defeating the AC ground with a two-prong adapter will usually defeat the hum but this practice can set up a shock hazard between the units. The hum level will depend on how the two units are connected to the AC. For minimal hum, use the same AC outlet for the Pro-One and its amplifier. This should reduce the hum to an acceptable level.

In short, we recommend the following steps when connecting the Pro-One:

1. Plug the Pro-One into a three-prong outlet. Don't defeat the AC ground.
2. Plug all other equipment such as amplifiers, volume pedals, and effects devices into the same outlet. Don't overload. When in doubt, consult an electrician.
3. Verify all equipment grounding with a ground tester.

Sequential Circuits, Inc. is not responsible for any equipment failure due to incorrect AC power connections, and is not liable for any personal injury due to electrical shocks as a result of poor grounding.

This is an excellent time to think about your amplifier and speaker system. By converting the synthesizer's electrical output to the potent vibrations you hear, your sound system becomes part of the instrument. Of course you can use anything you like. But if your speakers are muddy and weak, so will be your sound. Using your home stereo will generally give you good high-frequency range, but if you go this route be careful. The Pro-One has much more dynamic range than the typical stereo source. It can generate powerful transients which can damage component speakers if the volume is set too high. Therefore, you might consider using amplifiers and speakers specifically designed for electronic instruments.

The AUDIO OUT is a standard stereo phone jack, but it accepts a stereo or mono plug. For single-channel use with instrument amplifiers, a mono cable with mono plugs at both ends should suffice. For playing through both channels of a stereo amplifier, you will probably need a stereo cable with a stereo phone plug at one end and two phono plugs at the other. These will connect to the amplifier AUX or TAPE inputs. (To protect speakers, it is customary to switch off the amplifier when making these connections.)

Stereo headphones can be plugged directly into the AUDIO OUT jack. The headphones should have a minimum impedance of 600 Ohms.

When power and audio output connections have been made, first switch Pro-One power on with back panel switch, then switch amplifier power on. If you think the Pro-One may not be operating, see paragraph 1-7.

For other back panel connections, see Section 3.

1-2 PLAYING

At this point (after unpacking) the Pro-One is probably not ready to play. As a synthesizer, the knobs and switches on the control panel have to be set purposefully. Certain minimum conditions such as mixer volumes, filter cutoff frequency and envelope sustain level need to be established. You can learn about the controls by reading Section 2. But if you are like most people, you'll want to play the Pro-One before studying it. To do this, simply turn to Section 8 and select a factory patch. Set the Pro-One's controls as closely as possible to the diagram while playing on the keyboard. Patching is a fine art: be patient. Note that there is inherent error in the diagrams and some degree of subjective preference as to exactly where the knobs should be set. For completeness, all control positions are diagrammed even though some may have no effect (for example, PULSE WIDTH when the pulse wave shape is switched off.) When oscillator intervals are harmonically related, the FREQUENCY knob(s) will have to be tuned by ear, usually for a minimum of "beating."

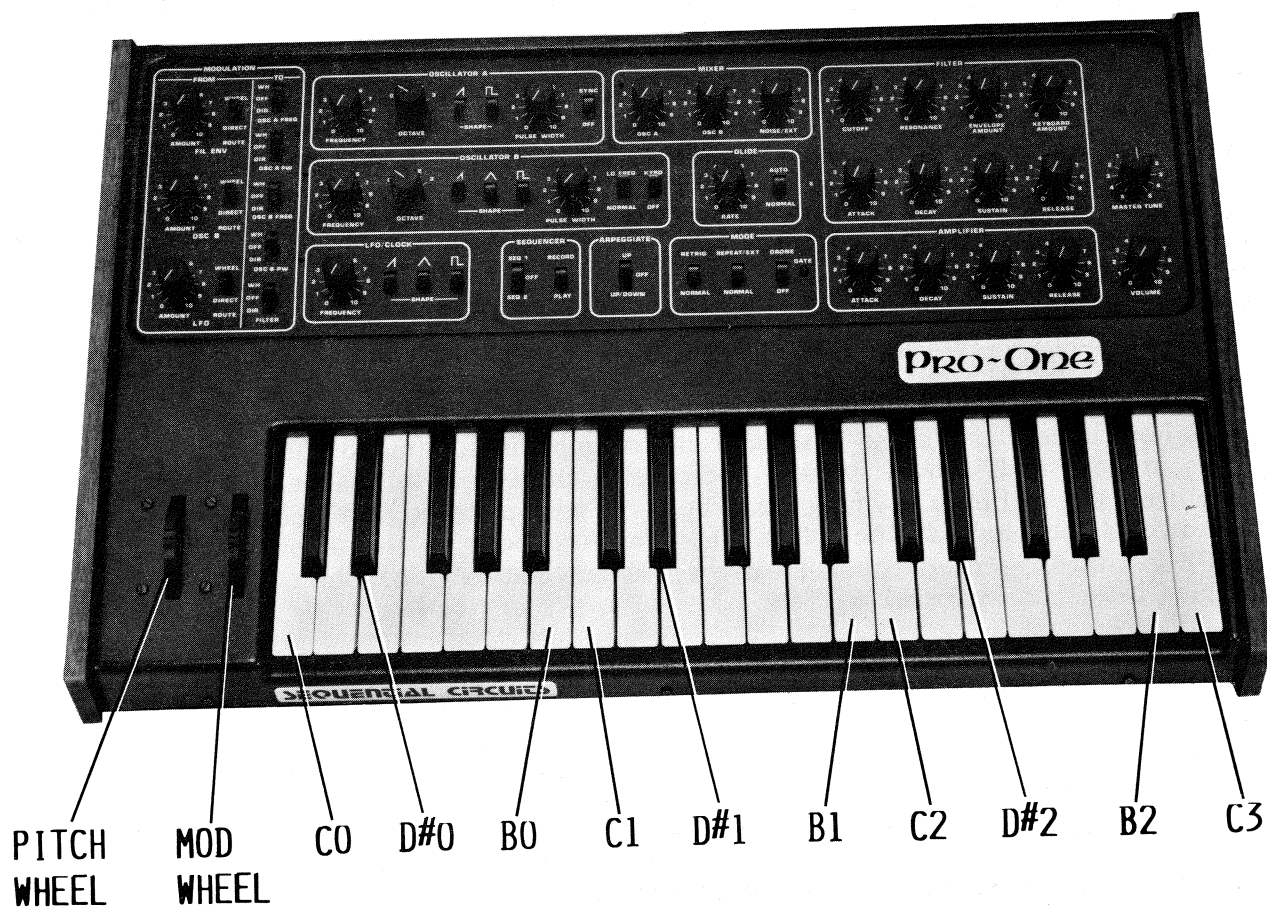

Figure 1-0
WHEELS and KEYBOARD

The MOD and PITCH wheels are at the left of the keyboard, as shown in Figure 1-0. The MOD wheel sets the modulation level. When not in use the wheel is left "down" and no modulation will occur. When the wheel is advanced fully "up," modulation is maximum. The PITCH wheel is normally left in its center-detent position, from which it is possible to simultaneously "bend" OSC A and OSC B pitch up or down by about a fifth. An integral part of playing is using the wheels and the module controls (e.g. GLIDE and FILTER ENVELOPE AMOUNT) for expression through dynamic and timbral variations.

The diagrams don't indicate VOLUME and MASTER TUNE knob settings because these are set as required. VOLUME, of course, sets the audio output level to the amplifier or headphones. For optimum signal-to-noise ratio, the Pro-One's VOLUME knob should be set as high as possible (without overdriving your amplifier or speakers, of course). MASTER TUNE simultaneously adjusts OSC A and OSC B pitch over a four-semitone range. It is used to easily tune the Pro-One to another instrument, such as a piano. Once set, MASTER TUNE is not usually adjusted during performance. If no other instrument is in use, the MASTER TUNE knob should be centered.

Other methods of controlling the Pro-One are possible via the back panel. For more information, see Section 3.

1-3 KEYBOARD CONTROLS

You can't play chords on a Pro-One for the same reason you can't play chords on a clarinet or trumpet: they are all monophonic instruments. So you will most often be playing solo lines on the keyboard. But you have some options as to how the keys are played, and when you can play more than one key. These are the keyboard controls, with which you can experiment on almost any patch. The keyboard controls include the arpeggiator and sequencer, which are keyboard "memory" devices of great utility in performance. And by freeing both hands from the keyboard, these tools aid your learning how to patch.

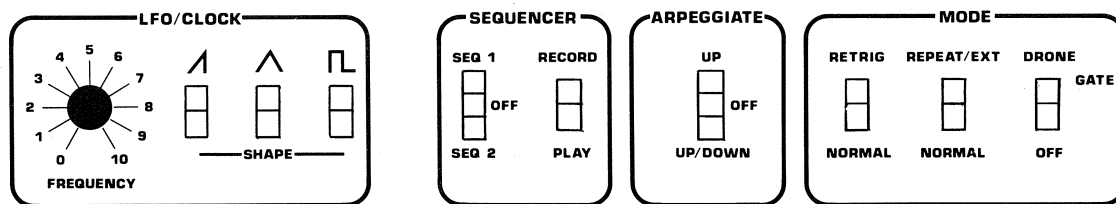

Figure 1-1
KEYBOARD CONTROLS

To understand the keyboard controls you first need to know that inside the Pro-One a GATE signal is produced when a key is played, which controls the envelope generators. The initial appearance of the GATE "triggers" the envelope generators to proceed through their ATTACK and DECAY periods. After the ATTACK and DECAY periods set for each envelope generator have elapsed, it will produce a steady control voltage (CV) at the level set by the SUSTAIN knob for as long as the GATE is present. When the GATE goes off, indicating the key has been released, the envelope generator output voltage decays to zero at a rate set by the RELEASE knob. (For more information, see paragraph 2-6.)

1-4 MODE

The MODE module contains a GATE indicator light-emitting diode (LED) to clarify operation in the various keyboard modes. And it eases adjustment of the external audio input GATE generator. (For more information, see paragraph 3-1.)

The NORMAL-RETRIG switch selects the envelope generator triggering mode. NORMAL means low-note priority with single triggering. That is, if you play more than one note at a time, the lowest note on the keyboard will be the one you will hear. Furthermore, all keys must be completely released before a new GATE (initiating new envelopes) will be produced. When switched to RETRIG (retriggering mode) a GATE will be produced whenever a new key is hit, regardless of its position on the keyboard or of the number of keys simultaneously held. In other words, the last key played will be the one you hear.

When switched up, the NORMAL-REPEAT/EXT switch repeatedly gates the envelope generators at a rate set by the LFO/CLOCK FREQUENCY knob. Activating this switch also enables the back-panel GATE/CLK IN input. When an external GATE is plugged into this jack, the LFO/CLOCK is overridden and the envelopes will be gated by the external GATE/CLK IN input. This signal will also clock (advance) the arpeggiator or sequencer (see below).

The DRONE switch simply forces the GATE on, holding the envelope generators at their SUSTAIN level. DRONE overrides REPEAT. With REPEAT or DRONE on, hitting keys will not retrigger the envelope generators, but it will change the frequency of both oscillators (providing OSC B KYBD is switched up), and of the FILTER, (providing the KEYBOARD AMOUNT knob is advanced).

1-5 ARPEGGIATE

The arpeggiator automatically sequences between any depressed keys either UP (ascending only), or UP/DOWN (ascending and descending) the keyboard. ARPEGGIATE speed is set by the LFO/CLOCK FREQUENCY knob. To arpeggiate, select UP/DOWN or UP and hold the desired keys. There is no limit to the number of keys which can be arpeggiated. Set LFO/CLOCK FREQUENCY as you wish. To stop the arpeggiator, return the direction switch to OFF.

The arpeggiator can be "latched," which means it continues to play keys even when you remove your hand(s) from the keyboard. To latch the arpeggiator, first turn it on, hold the desired keys, then switch SEQUENCER PLAY-RECORD to RECORD. After all held keys have sounded at least once, you can remove your hand--the Pro-One will continue to arpeggiate. To "unlatch" the arpeggiator, switch from RECORD to PLAY.

You can't change directions in the middle of an arpeggiate sequence. If you do switch from UP to UP/DOWN or vice versa, the Pro-One will wait until all held or latched notes have been arpeggiated in one direction before it recognizes the change of direction.

While the arpeggiator is latched, you can hold additional keys which will sound as part of the arpeggiate sequence only as long as they are held. These additional notes remain "unlatched." Note: even though the SEQUENCER RECORD switch is used to latch the arpeggiator, the SEQUENCER memory banks are not affected (see also paragraph 1-6).

1-6 SEQUENCER

The Pro-One's 40-note sequencer allows you to record themes, riffs, walking bass lines or the like. All sequenced notes and rests are single-step recorded with the same duration. (Unlike "real-time" sequencers like our Model 800 and Model 1015, the Pro-One sequencer does not record notes of varying duration.) No matter how unevenly you record a Pro-One sequence, it will always play-back with all notes and rests evenly timed. The playback speed is controlled by the LFO/CLOCK FREQUENCY knob. The 40-note memory capacity is divisible in any proportion between two "banks," referred to as SEQ 1 and SEQ 2.

When the Pro-One is switched on, its sequencer is preprogrammed with a 20-note ascending scale in SEQ 1 and a 20-note descending scale in SEQ 2. Provided the PLAY-RECORD switch is down, you can now hear these two sequences by just switching the bank selector to SEQ 1 or SEQ 2.

To record, first switch PLAY-RECORD up, then select SEQ 1 or SEQ 2. Simply play the notes on the keyboard, inserting rests by switching from RECORD to PLAY, then back to RECORD. Rhythmic variations can only be arranged by inserting rests. All notes must be played detached, as you would in NORMAL--as opposed to RETRIG--mode (see paragraph 1-4). A sequence cannot begin with a rest.

Be sure to not exceed the 40-note capacity, or the sequence will be destroyed. When the 41st note or rest is entered, the first 40 notes are cleared. The bank then contains one note.

When finished recording, first switch the bank selector OFF, then switch from RECORD to PLAY.

When switched to PLAY, the Pro-One will sequence the notes and rests you recorded in the selected bank at a rate set by the LFO/CLOCK FREQUENCY knob. (Or, the sequencer can be advanced by pulses at the GATE/CLK IN jack. See Section 3.) The sequence will play continuously ("loop") until the bank selector is switched OFF.

When both memory banks are being used, care must also be taken to not exceed the 40-note limit. The Pro-One assigns memory priority to the bank which is currently being recorded, and will "steal" notes from the other bank once the 40 total note limit is reached. For example, if SEQ 1 already has a 25-note sequence recorded in it, you will erase SEQ 1 if you attempt to record more than 15 notes in SEQ 2. (SEQ 2 then retains the additional notes.)

As shown in Figure 1-0, the Pro-One's keys are named C0, C#0, D0...through C3. In playback, the entire sequence can be transposed over a two-octave range by just hitting a key between C0 and C2. The transposition is equal to the interval between C1 and the key played. For example, to transpose down a fifth, hit F0. To transpose up a major seventh from the original key, hit B1. To transpose back to the original key, hit C1.

The sequencer memory banks will retain their contents until power is switched off (or interrupted). Any transposition is cleared as well.

1-7 IN CASE OF DIFFICULTY

To check that the Pro-One is receiving power, switch DRONE on. The GATE LED should light. If it doesn't, either power is not reaching the unit or the internal fuse has blown. First check the power source by plugging in other equipment. Examine the Pro-One's power cable for damage. To check fuse, see Section 4.

If the GATE LED lights but no sound can be obtained, check the front panel controls--including VOLUME--carefully against a factory patch in Section 7.

If still no sound can be heard, try substituting the audio output cable with one known to be good.

Check your amplifier by trying a high-level audio input such as another synthesizer or an FM tuner.

Check headphones by trying them with a standard headphone output from a stereo amplifier.

If the SEQUENCER won't record, check that you didn't leave ARPEGGIATE on.

If you are having trouble recording or playing sequences or arpeggiating, it may help to reset the internal microcomputer by switching power off then back on after a moment. Note this will erase any sequences which you have recorded.

Other problems may be rectified by "user trim" procedures given under Section 4, Routine Maintenance.

Authorized U.S. and Canadian Service Centers are listed in Section 5. If these locations are too inconvenient, please contact the factory Service Department.

FRONT PANEL

2-0 INTRODUCTION

This section explains the "modules" outlined on the front panel. The front panel is divided into "voice" and "modulation" sections. The basic voice is discussed first, then modulation. Signal flow, the alternatives of each switch, and ranges of each knob are described.

2-1 THE VOICE

As an analog voltage-controlled synthesizer voice, the Pro-One can be understood at its most general level in terms of three functions: audio waveshape generation, modification, and control.

Figure 2-0 diagrams voice signal flow. As mentioned above (**About the Pro-One**), OSC A and OSC B are the principal sound generators. They are supplemented by the NOISE source (for unpitched sounds such as "surf") or an external audio input which bypasses the NOISE source. (To learn how to use the external audio input, see paragraph 3-1.)

The MIXER is a modifier. It sets OSC A, OSC B, and NOISE (or EXT audio) levels and combines them into one signal which enters the FILTER. The FILTER also functions normally as a modifier, by cutting off the high-frequency components of input audio signals. However, by feeding a sufficient amount of FILTER output back to its input with the RESONANCE control, the FILTER will become a pitch generator at its CUTOFF frequency.

The AMPLIFIER stage is also a modifier because it raises or lowers the signal level from the FILTER to the external power amplifier and speaker. The AMPLIFIER is controlled by its own envelope generator and the VOLUME control, which attenuates the generator's control voltage output, reducing the overall output level.

OSC A, OSC B, the FILTER, AMPLIFIER, and envelope generators are all voltage-controlled. Mechanical devices such as the keyboard, switches, knobs and wheels form one group of controllers. The other group is electronic, consisting of the LFO, OSC B, and FILT ENV modulation sources. The term "modulation" refers to a periodic or consistent (as opposed to random) aural change which is interesting or musically useful. Modulation is created with electronic controllers when it is not possible to adjust a mechanical controller with the required speed or precision. Electronic controllers free the hands for other uses.

The keyboard is the most conspicuous controller. It issues a CV which increases as you play upwards from C0 to C3. This keyboard control voltage (KYBD CV) always

WAVE SHAPE GENERATION → COMBINATION → TIMBRE MODIFICATION → LOUDNESS MODIFICATION

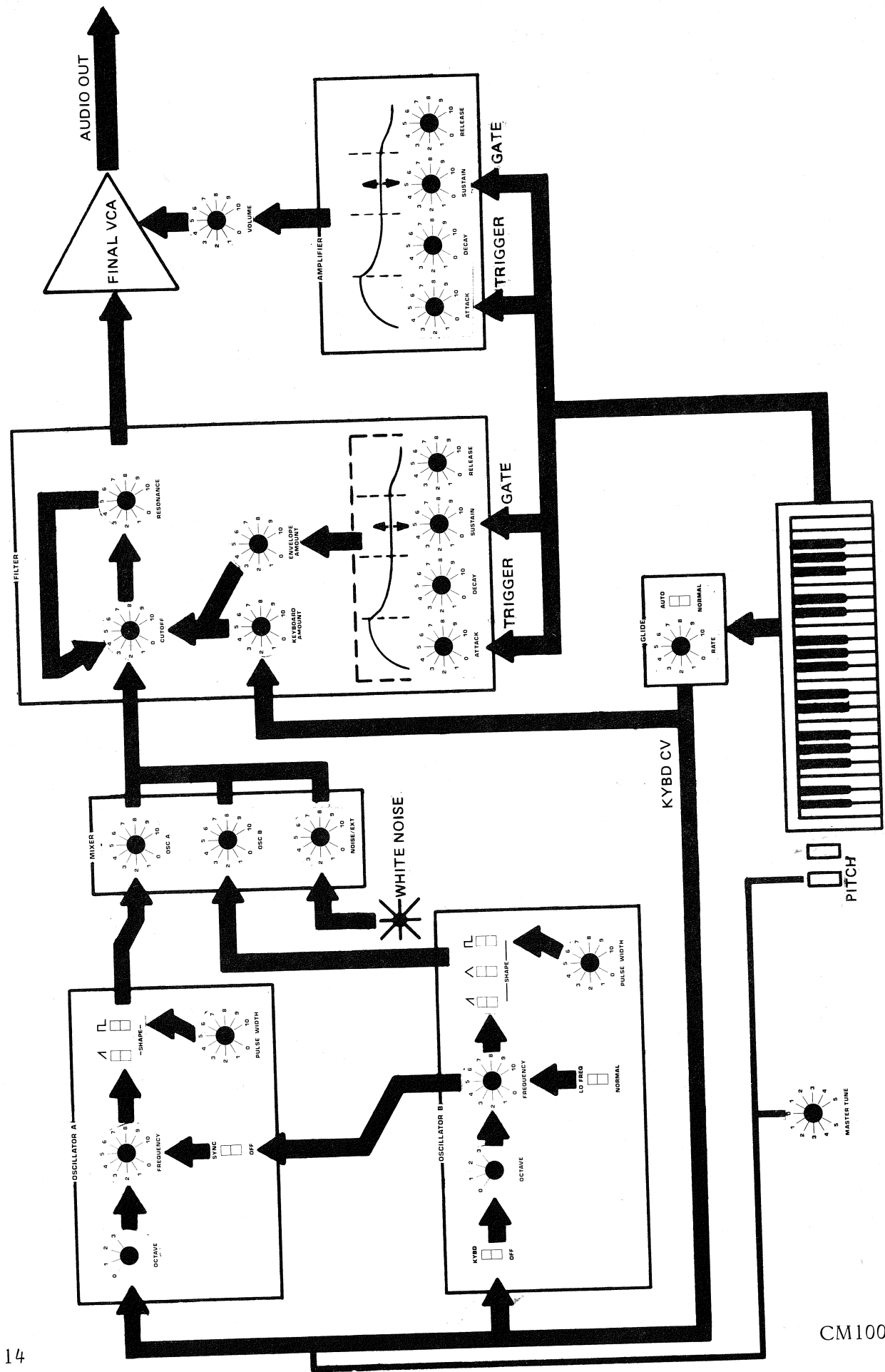

Figure 2-0
VOICE SIGNAL FLOW

controls OSC A's frequency, and controls OSC B frequency if the OSC B KYBD switch is on. The KYBD CV also controls the FILTER CUTOFF frequency to the extent the FILTER KEYBOARD AMOUNT knob is advanced. The TRIGGER/GATE produced by the keyboard controls the envelope generators, which in turn control the FILTER cutoff frequency and AMPLIFIER gain.

A few controllers also produce GATES or TRIGGERS which control the envelope generators. For example, when the MODE is switched to REPEAT, the LFO gates the envelopes.

The oscillator FREQUENCY and filter CUTOFF knobs are controllers which set initial frequency over a continuous range. The oscillator OCTAVE switches are controllers which transpose by exact octaves. The envelope ADSR knobs are also, in actuality, control voltage sources.

2-2 OSCILLATOR A

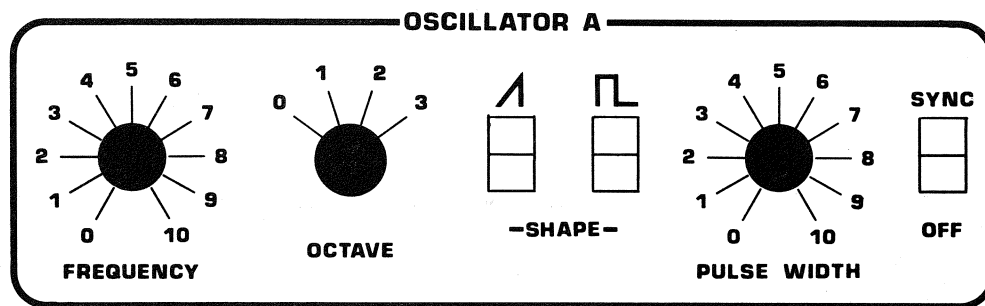

Figure 2-1

OSC A is an audio frequency source always under control of the keyboard.

FREQUENCY knob: Adjusts initial frequency continuously over a one-octave range.

OCTAVE rotary switch: Transposes initial frequency over a four-octave range.

SAWTOOTH SHAPE switch: Enables full-level waveshape containing all harmonics. This unmodified shape is often described as "brassy."

PULSE SHAPE switch: Enables full-level waveshape whose harmonic content depends on setting of PULSE WIDTH knob.

If neither waveshape switch is on, OSC A will have no output to the MIXER. If both waveshape switches are on, the sawtooth and pulse are mixed at full level and supplied as OSC A's output to the MIXER.

PULSE WIDTH knob: Adjusts the harmonic content of the pulse wave by setting pulse wave duty cycle from 0 to 100%. A 50% duty-cycle pulse, also called a square wave, can be obtained by setting the knob to 5, then carefully adjusting for the dropout of the second harmonic (the first octave overtone). At the extreme knob settings the pulses may "thin out" until they degenerate to dc, resulting in no output signal. This knob has no effect on the sawtooth wave.

SYNC switch: Forces OSC A to follow OSC B in hard synchronization. Intermediate FREQUENCY settings will produce unusual timbres at the next lower harmonic of OSC B. When a wide-width pulse is selected for OSC A in sync with OSC B, and OSC B's frequency is set much higher than OSC A, the signal from OSC A may degenerate to dc since the pulse is not given a chance to discharge before being re-synced.

2-3 OSCILLATOR B

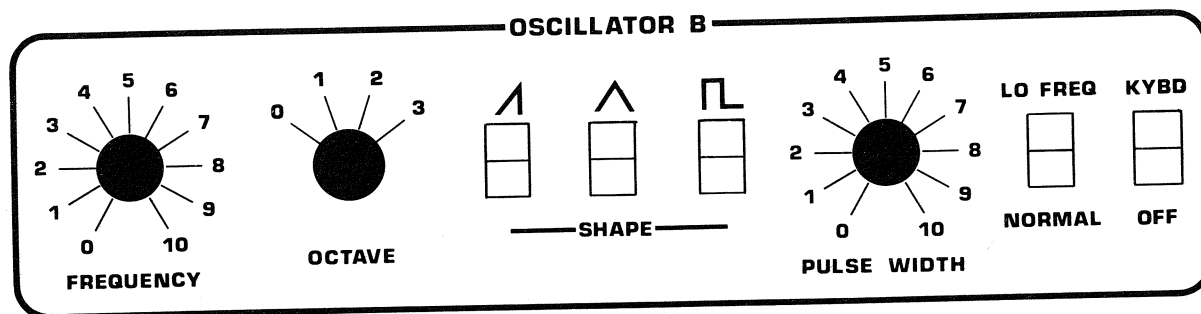

Figure 2-2

OSC B is similar to OSC A, except that in addition to being a keyboard-controlled audio frequency source, it can also be a low-frequency, modulation source with or without keyboard control. The identically named controls function as described under OSC A. In addition:

TRIANGLE SHAPE switch: Enables waveshape which is centered at ground so as not to offset modulation destination. When used in the audio range, this shape provides little harmonic energy.

NORMAL-LO FREQ switch: Extends OSC B range to sub-audio frequencies.

OFF-KYBD switch: Allows keyboard control or independent operation.

When OSC B is used as an audio source, usually LO FREQ is switched to NORMAL and KYBD is switched on.

2-4 GLIDE

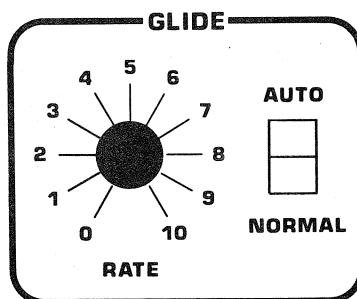

Figure 2-3

The GLIDE module is a "lag processor." It sets the rate of change for the KYBD CV. When set to zero, the KYBD CV instantly steps between notes. As the GLIDE knob is advanced, the KYBD CV does not step quickly between the notes, but begins instead to "slew" between them.

RATE knob: Determines the rate of glide (portamento) between notes.

NORMAL-AUTO switch: In NORMAL, Glide operates in the traditional manner. In AUTO, the keyboard will glide only when a new key is hit with the previous key still held. This enables complex, "tuned" pitch bending with one hand.

2-5 MIXER

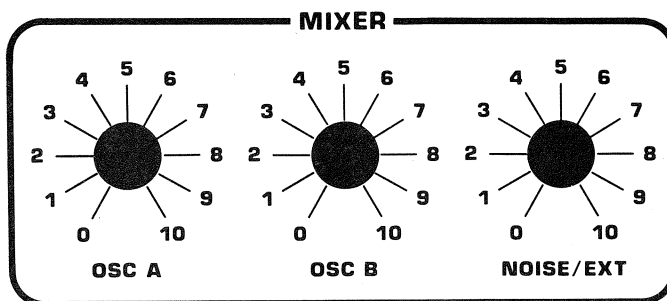

Figure 2-4

OSC A and OSC B knobs: Set the level of oscillator input to the FILTER.

NOISE/EXT knob: Sets the white noise level input to the FILTER. Noise is an unpitched source useful for effects such as surf, wind or cymbals. When the back-panel external audio input is used, noise is bypassed and this knob sets the level of external signal input to the FILTER.

To get any sound out of the Pro-One, at least one of these three knobs must be turned up (unless the filter is being used as a pitch source).

2-6 FILTER

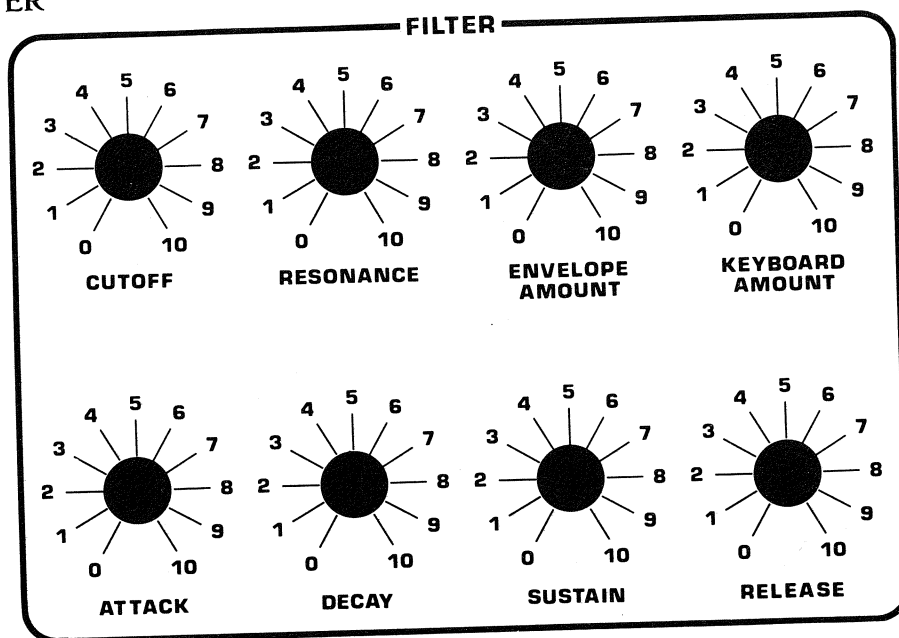

Figure 2-5

The FILTER module contains controls for the filter itself and for its envelope generator.

CUTOFF knob: Sets cutoff frequency for the 24 db/octave (4-pole) low-pass filter. It is rather like a tone control. Cutoff is the frequency below which all elements of a signal are let through. The higher-frequency components of the signal (i.e. all those above the cutoff frequency) are suppressed. The higher the knob is set, the higher the frequencies that are allowed through the filter.

RESONANCE knob: Determines the amount of filter resonance. As the setting is increased from 0 to approximately 7 the amount of resonance ("emphasis," "regeneration," or "Q") applied to those signal components at the cutoff frequency will increase. The components far below the cutoff frequency will be less audible relative to the frequencies being resonated. As the setting is increased beyond 7, the filter breaks into oscillation and will act as a sine-wave audio source whose pitch is determined by the cutoff frequency.

ENVELOPE AMOUNT knob: Sets amount (not the shape) of ADSR filter envelope CV controlling the filter cutoff frequency. The filter envelope generator is discussed below.

KEYBOARD AMOUNT knob: Determines the amount of KYBD CV controlling the filter cutoff frequency. When set between 7 and 8, the filter cutoff frequency is maintained at a constant point relative to the notes played on the keyboard, creating consistent tone. When set to 10, notes played higher on the keyboard will have less of their overtones suppressed than those played on the lower end of the keyboard. As a result, the higher notes will have a brighter timbre. When reduced or off, notes played higher on the keyboard will have more of their overtones suppressed than noted played lower. As a result the higher notes will have a duller timbre.

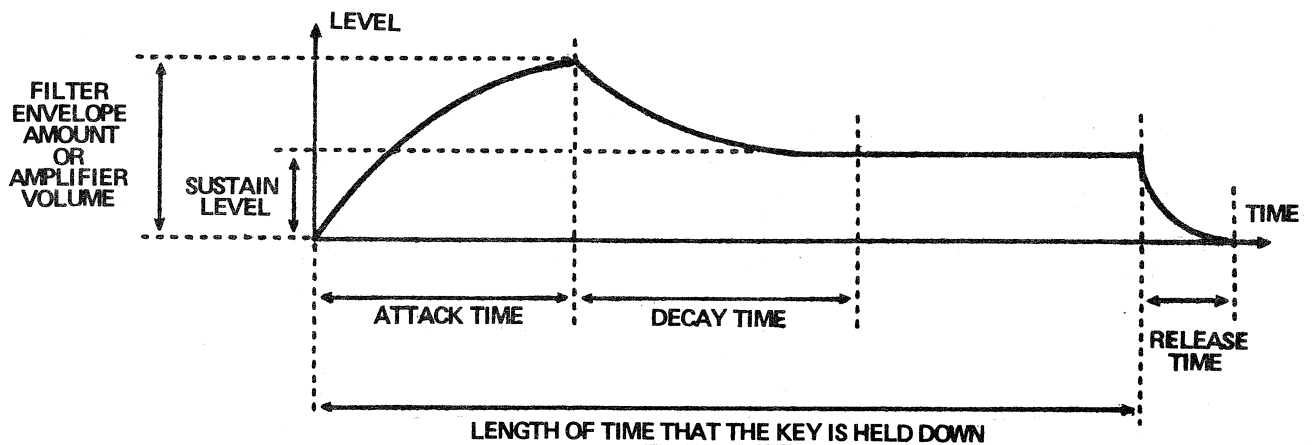

Figure 2-6
ENVELOPE

The filter envelope generator contours timbre by controlling the filter cutoff frequency. The entire contour pattern is initiated when a key is struck, producing a GATE. The initial appearance of the GATE "triggers" the envelope generators to proceed through their ATTACK and DECAY periods. After the ATTACK and DECAY periods set for each envelope generator have elapsed, it will produce a steady control voltage (CV) at the level set by the SUSTAIN knob for as long as the GATE is present. When the key is released, the GATE goes off and the envelope generator output voltage drops to zero at a rate set by the RELEASE knob.

ATTACK knob: Varies time for envelope to increase from zero to maximum, from 2 milliseconds to more than 6 seconds.

DECAY knob: Varies time for envelope to decrease from maximum to SUSTAIN level, from 2 milliseconds to more than 6 seconds.

SUSTAIN knob: Varies level from zero to maximum. Remember, this is a level control, not a time control. (SUSTAIN time is the period between the end of the DECAY and when the key is released.)

If SUSTAIN is set at maximum then the DECAY knob setting is irrelevant.

RELEASE knob: Varies time for envelope to decrease from sustain level to zero, from 2 milliseconds to more than 6 seconds. If the key is released before either the ATTACK or DECAY periods have elapsed, this knob controls the time taken for the output to drop to zero from its level when the key was released.

If the ATTACK and DECAY periods have elapsed and SUSTAIN is set to 0, the RELEASE knob setting is irrelevant.

2-7 AMPLIFIER

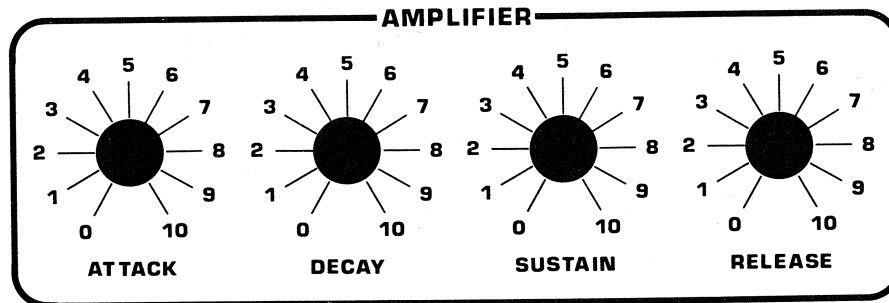

Figure 2-7

The ATTACK, DECAY, SUSTAIN, and RELEASE knobs in this module shape the envelope applied to the final VCA in the same manner as the corresponding controls in the FILTER module.

Unless the SUSTAIN knob is somewhat advanced, nothing will be heard after the ATTACK and DECAY periods have elapsed.

2-8 MODULATION

A synthesizer's expressiveness stands on its modulation facilities. The Pro-One has three modulation sources which are fully mixable and routable over simultaneous WHEEL-controlled or DIRECT paths to five destinations in the voice itself.

Two of the three modulation sources (filter envelope generator and OSC B) were described above. The third source is the LFO.

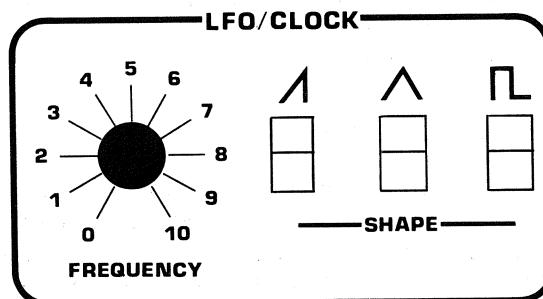

Figure 2-8

FREQUENCY knob: Varies LFO range from approximately .1 to 30 Hz.

Waveshape switches: Function identically to OSC B.

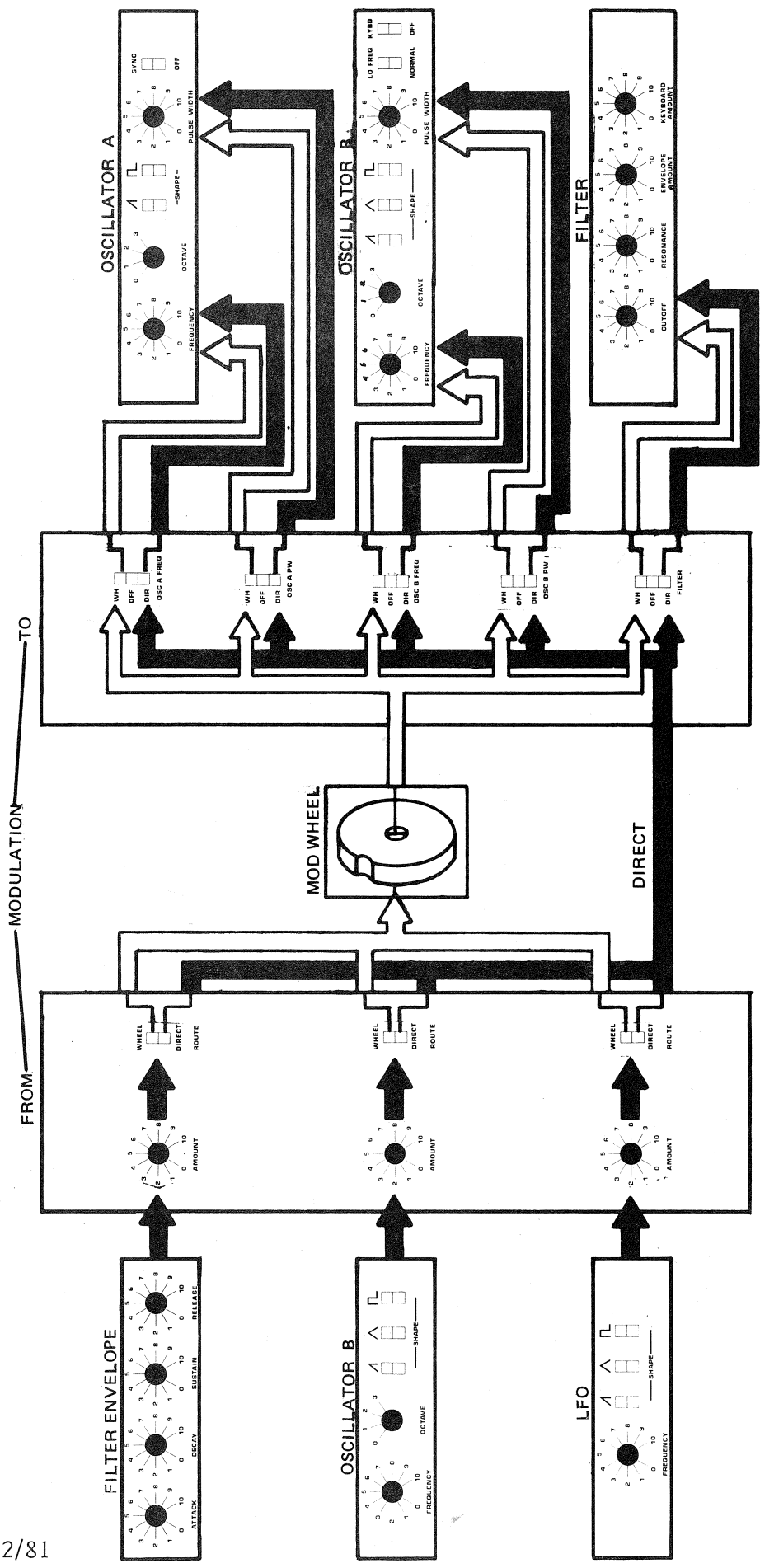

Figure 2-9
MODULATION SIGNAL FLOW

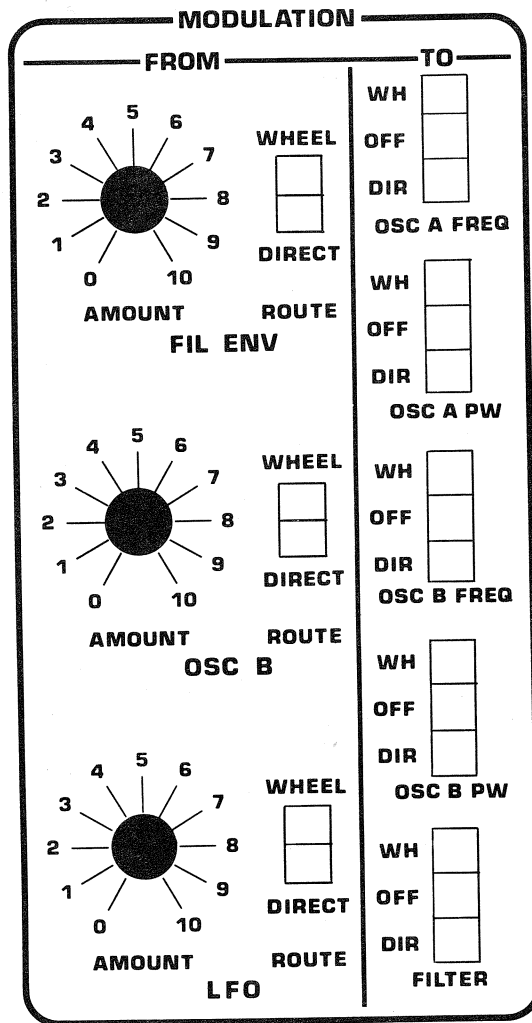

Figure 2-10
MODULATION

FIL ENV, OSC B, and LFO AMOUNT knobs: Determine the amount of modulation mixed into the WHEEL or DIRECT paths by the adjacent ROUTE switches.

FIL ENV, OSC B, and LFO ROUTE switches: Assign the modulation sources to either the WHEEL or DIRECT paths. Each source routed DIRECT is mixed and applied directly to the selected destination, while those routed WHEEL are mixed then sent to the MOD wheel which determines the depth of modulation.

OSC A FREQ, OSC A PW, OSC B FREQ, OSC B PW, AND FILTER switches: Select the WHEEL or DIRECT modulation path (or neither) for each destination.

3-0 INTRODUCTION

This section describes all connections which may be made via the back panel jacks. Except for AUDIO OUT, all jacks accept a standard 1/4" mono phone plug. (The digital interface is described in paragraph 5-6.)

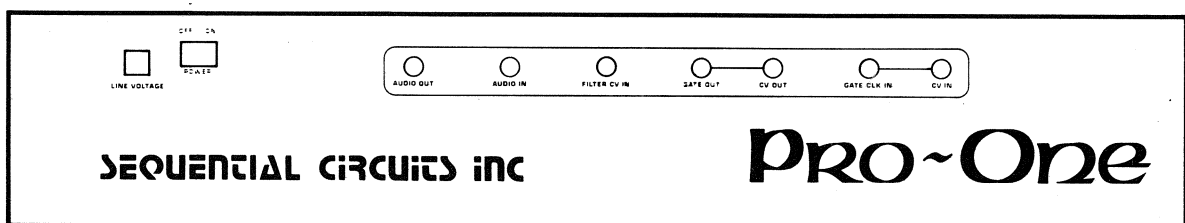

Figure 3-0
BACK PANEL

3-1 AUDIO IN

This jack allows an external audio input to be mixed and processed by the Pro-One's filter and amplifier. The input drives an internal envelope detector which generates a GATE once the input level has passed the threshold set by the MIXER NOISE/EXT knob. The GATE which is produced controls the filter and amplifier envelope generators. This GATE can also advance the arpeggiator or sequencer when these keyboard controls are selected. It overrides both the LFO/CLOCK and the GATE/CLK IN input (see below).

To enable the gate generator, REPEAT/EXT MODE must be selected. The input is very sensitive, being drivable by a microphone or electric guitar pickup. Line-level audio can overdrive the input. The principle for correct adjustment of the GATE generator is to set the MIX NOISE/EXT knob at the minimum level necessary for consistent or adequate gating. Observe the GATE LED for aid in adjustment.

3-2 FILTER CV IN

This jack accepts 0-10 Vdc, usually provided by a voltage pedal for control of the filter cutoff frequency at a scale of 1V/octave. When connected, this CV overrides the normal KYBD CV, but may still be attenuated with the FILTER KEYBOARD AMOUNT knob.

3-3 GATE OUT

This digital signal follows the GATE status as indicated by the GATE LED. That is, whenever a note is played on the keyboard or by the arpeggiator or sequencer in playback, GATE OUT will be high (+5V-nominal).

3-4 CV OUT

This jack makes the 1V/octave KYBD CV available for control of external equipment. It basically ranges 0.083V to 3.083V (three octaves), following the keyboard or sequencer. If the sequencer is transposed (see paragraph 1-6), CV OUT can range -1V to 4V.

3-5 GATE/CLK IN

Once this digital input is enabled by selecting the REPEAT/EXT MODE, it provides for envelope gating, or sequencer or appegiate clocking by an external (+5V-nominal) pulse.

3-6 CV IN

This jack accepts 0-10 Vdc for control of the oscillators and filter at a scale of 1V/octave. Similarly to the FILTER CV IN jack, when connected, CV IN overrides the normal KYBD CV, but may still be switched by the OSC B KYBD switch and attenuated by the FILTER KEYBOARD AMOUNT knob. (For the FILTER, FILTER CV IN overrides CV IN.)

If your sound disappears when you connect to this input, you may be driving the oscillators into the superaudio range. Reducing the external CV will return the oscillator frequencies to the range of human hearing.

ROUTINE MAINTENANCE

4-0 INTRODUCTION

This section covers all maintenance which the player can be expected to perform.

4-1 CLEANING

The external metal surfaces and plastic keys can be cleaned with mild soap and water. Don't use alcohol, ammonia, or phosphate-based cleaners. They can remove the paint and ruin the key finish.

4-2 USER TRIM

This paragraph describes adjustment of the four trimmers accessible through the front panel. All four trimmers interact, so this procedure must always be completed in the order presented. The entire procedure is done by ear, without instruments. What you will be listening for is often described below by the term "zero-beat." This refers to the principle that two pitches near the same frequency produce "beats" at a rate equivalent to their difference. For example, if your ear is presented with two pitches such as 440 (A) and 444 Hz, it will hear also four beats-per-second. As one pitch approaches the other, the number of beats-per-second decreases until they can hardly be counted. This point is called "zero-beat," indicating the two oscillators are tuned to exactly the same frequency (or some harmonic "overtone").

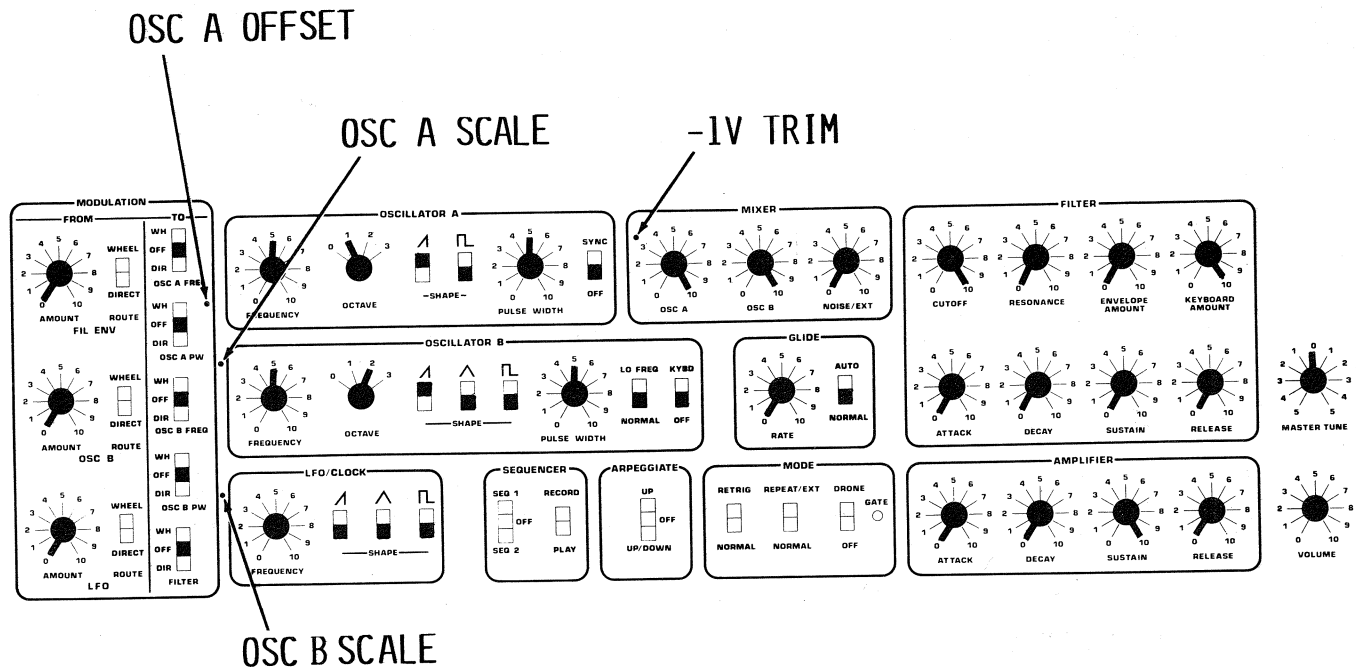

Figure 4-0
USER TRIM PATCH

--OSC A SCALE--

1. Patch according to Figure 4-0. Note trimmer names and locations.
2. Hit C1 (see Figure 1-0) and adjust OSC B FREQUENCY in tune (zero-beat) with OSC A. (This sets-up OSC B for use as a reference.)
3. Hit C0 and adjust OSC A FREQUENCY for zero-beat.
4. Hit C3 and again adjust OSC A FREQUENCY for zero-beat. If this required increasing OSC A FREQUENCY to attain zero-beat, turn OSC A SCALE trimmer clockwise (CW) a small amount. If OSC A FREQUENCY needed decreasing, turn OSC A SCALE trimmer counter-clockwise (CCW) a small amount.
5. Repeat steps 3 and 4 until both ends of the keyboard tune with zero beats.

-- -1V TRIM--

6. Switch OSC A OCTAVE to 0.
7. Switch OSC B OCTAVE to 0.
8. Hit C0 and adjust OSC A FREQ for zero-beat.
9. Switch OSC A OCTAVE to 3.
10. Adjust -1V TRIM for zero-beat.

--OSC B SCALE--

11. Switch OSC A OCTAVE to 1.
12. Switch OSC B OCTAVE to 1.
13. Switch OSC B KYBD on.
14. Hit C0 and adjust OSC B FREQ for zero-beat.
15. Hit C3 and again adjust OSC B FREQUENCY for zero-beat. If this required increasing OSC B FREQUENCY to attain zero-beat, turn OSC B SCALE trimmer clockwise (CW) a small amount. If OSC B FREQUENCY needed decreasing, turn OSC B SCALE trimmer counter-clockwise (CCW) a small amount.
16. Repeat steps 14 and 15 until both ends of the keyboard tune with zero beats.

--OSC A OFFSET--

17. Adjust OSC A FREQUENCY to 0.
18. Switch OSC A OCTAVE to 3.
19. Adjust OSC B FREQUENCY to 0.
20. Switch OSC B OCTAVE to 3.
21. Hit C0. Trim OSC A OFFSET for zero-beat.

4-3 OPENING

1. Switch power off.
2. Unplug power cord.
3. Remove wooden side panels (2 screws each side).
4. Remove three screws along front edge.
5. Carefully slide top panel assembly forward. When front edge is clear of keys, lift it up just enough to allow clearance for your hand.
6. Reach in and disconnect AC power connector running from back panel to underside of printed circuit board (PCB), at right. (When reconnecting, orient connector so the side through which you can see the metal contacts is visible.)
7. Also disconnect keyboard cable from PCB. (When reconnecting, the keyboard cable should be twisted so that the ribbon crosses over the board. If correct, the numbers 9-16 stamped on the connector will run along the PCB edge.)
8. Assembly is just the reverse of these steps.

4-4 FUSE

The fuse must be changed whenever the line voltage is switched (as discussed in paragraph 1-1). A 1/4-amp SLO-BLO fuse should be used for 115V operation. A 1/8-amp SLO-BLO fuse should be used for 230V operation.

The fuse should be checked when the Pro-One does not appear to be working (as discussed in paragraph 1-7).

To check or change the fuse, first unplug the power cord then open the case as described above. Lift the top panel assembly off and turn it over. The fuse can be found to the right, mounted to clips on the PCB underside.

5-0 INTRODUCTION

The information in this section is provided for reference by qualified service technicians only. We recognize that circumstances may arise in which this data may have critical value for the player. We are making these procedures available with the understanding that our warranty terms are not affected. In short, as an owner you void your warranty if you attempt these procedures on the Pro-One.

5-1 REMOVING PCB

1. Open the Pro-One as directed in paragraph 4-3.
2. Pull off all knobs.
3. Disconnect wheel connector at left of PCB. (When reconnecting, orient connector so that the side in which you can see the metal contacts is visible.)
4. Remove 9 screws holding PCB to top panel (there are two screws near the transformer).
5. The PCB should now lift away from the top panel. If not, check that the GATE LED is not stuck or cemented.
6. Set the PCB on insulation on the bottom panel, and reconnect AC and keyboard. Switch power on, and allow the instrument to warm up for at least ten minutes before proceeding.

WARNING! LETHAL VOLTAGE IS PRESENT IN THE POWER SUPPLY AREA ON THE PCB UNDERSIDE

5-2 DAC SCALE

This adjustment should not be performed as part of the tuning procedure. In fact, readjustment may only be necessary if a repair has been made. Whenever this adjustment is made the Pro-One will have to be completely retuned. A $3\text{-}1/2$ digit voltmeter (DVM) is required.

1. Connect DVM to back-panel CV OUT jack.
2. Hit C0 and note reading. The reading will be approximately 0.083V. (The absolute value of this reading is not critical.)
3. Hit C1 and note reading, which should be the value read in step 2, plus exactly 1V. If necessary, adjust R1181 DAC SCALE for the exact reading; e.g. 1.083V.

4. Repeat steps 2 and 3 as required to establish an exact 1V difference between CV OUT played by C0 and C1.

5-3 TUNING

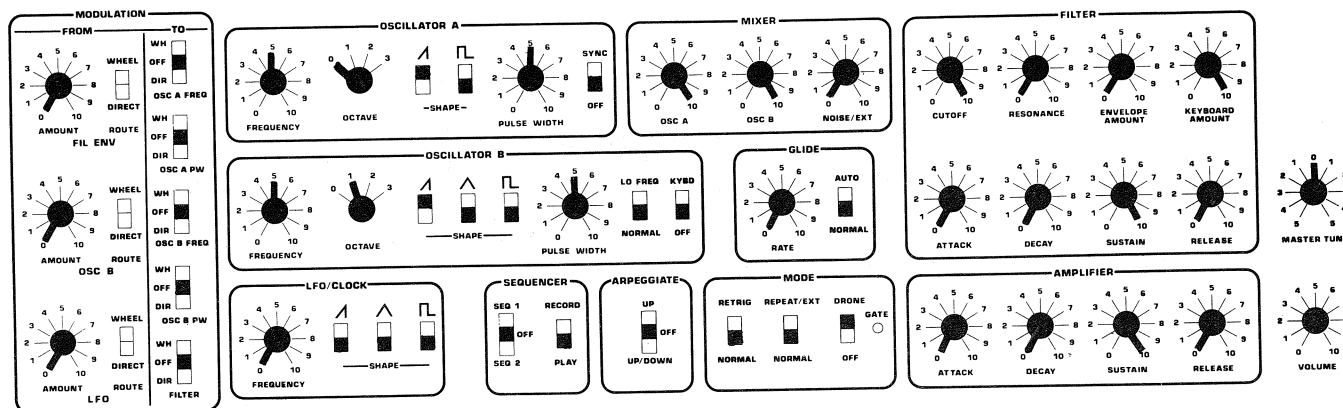

Figure 5-0
TUNING PATCH

--OSC A SCALE--

1. Patch according to Figure 5-0. For component locations, see Figure 5-1.
2. Turn R135 OSC A HI SCALE fully counterclockwise (CCW).
3. Hit C1 and adjust OSC B FREQUENCY for zero-beat.
4. Hit C0 and adjust OSC A FREQUENCY for zero-beat.
5. Hit C3 and adjust OSC A FREQUENCY for zero-beat. If this required increasing OSC B FREQUENCY, turn R128 OSC A SCALE trimmer clockwise (CW) a small amount. If OSC B FREQUENCY needed decreasing, turn OSC B SCALE trimmer counter-clockwise (CCW) a small amount.
6. Repeat steps 4 and 5 until both ends of the keyboard tunes with zero beats.

--OSC A HI TRIM--

7. Switch OSC A OCTAVE to 2.
8. Switch OSC B OCTAVE to 3.
9. Hit C0 and adjust OSC A FREQUENCY for zero-beat.
10. Hit C3. Adjust R135 OSC A HI TRIM for zero-beat.
11. Repeat steps 9 and 10 until no improvement can be made.

R120 OSC A OFFSET
 R128 OSC A SCALE
 R135 OSC A HI TRIM
 R1111 -IV TRIM
 R1181 DAC SCALE
 R1138 VCA BALANCE

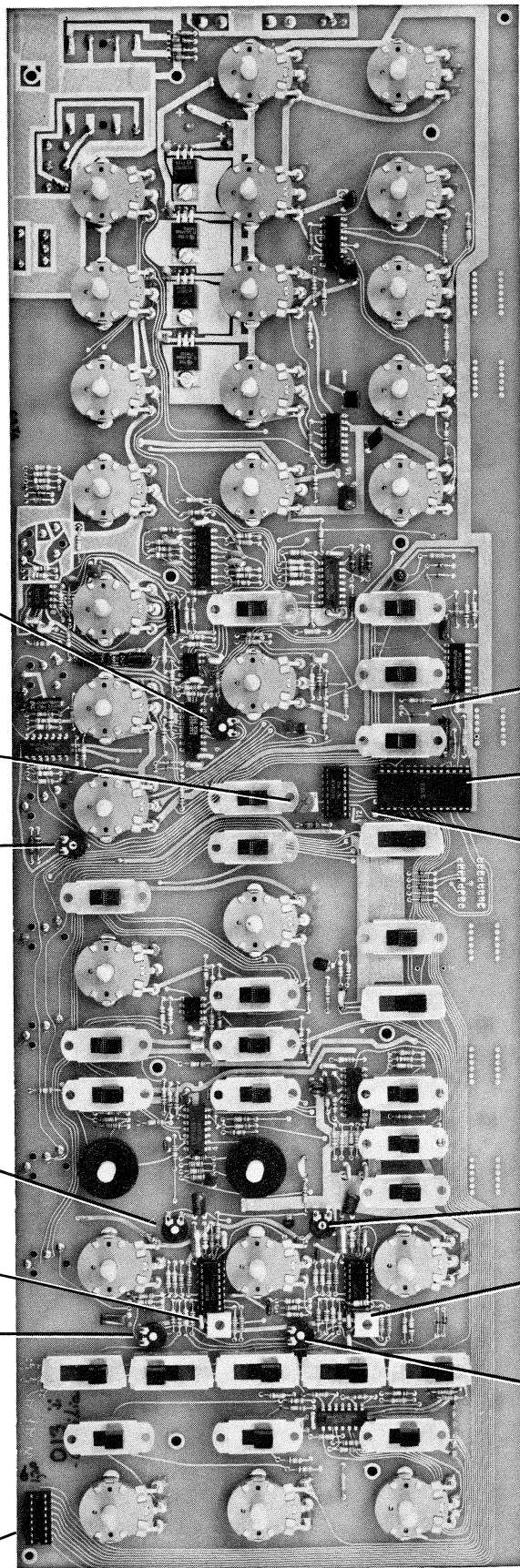

R140 OSC B OFFSET
 R148 OSC B SCALE
 R157 OSC B HI TRIM
 JUMPER U113 (OPTIONAL) 8021 (OPTIONAL)
 R1182

Figure 5-1
PCB

-- -1V TRIM--

12. Switch OSC A OCTAVE to 0.
13. Switch OSC B OCTAVE to 0.
14. Hit C0 and adjust OSC A FREQUENCY for zero-beat.
15. Switch OSC A OCTAVE to 3.
16. Adjust R1111 -1V TRIM for zero-beat.

--OSC B SCALE--

17. Switch OSC A OCTAVE to 0.
18. Switch OSC B OCTAVE to 0.
19. Switch OSC B KYBD on.
20. Hit C0 and adjust OSC B FREQUENCY for zero-beat.
21. Hit C3 and again adjust OSC B FREQUENCY for zero-beat. If this required increasing OSC B FREQUENCY to attain zero-beat, turn R148 OSC B SCALE trimmer clockwise (CW) a small amount. If OSC B FREQUENCY needed decreasing, turn OSC B SCALE trimmer counter-clockwise (CCW) a small amount.
22. Repeat steps 20 and 21 until both ends of the keyboard tunes with zero beats.

--OSC B HI TRIM--

23. Switch OSC A OCTAVE to 3.
24. Switch OSC B OCTAVE to 3.
25. Hit C0 and adjust OSC B FREQUENCY for zero-beat.
26. Hit C3. Adjust R157 OSC B HI TRIM for zero-beats.
27. Repeat steps 25 and 26 until no improvement can be made.

--OSC A/B OFFSET--

28. Check that PITCH WHEEL and MASTER TUNE are centered.
29. Switch OSC A OCTAVE to 1.
30. Turn OSC A FREQUENCY to 0.
31. Switch OSC B OCTAVE to 1.
32. Turn OSC B FREQUENCY to 0.
33. Switch OSC B sawtooth off.

34. Using an external reference (tuning fork, piano, or Prophet), adjust R120 OSC A OFFSET so key A2 pitch is A-440.
35. Switch OSC B sawtooth back on.
36. Switch OSC A OCTAVE to 3.
37. Switch OSC B OCTAVE to 3.
38. Hit C1 and adjust R140 OSC B OFFSET for zero-beat with OSC A.

5-4 AMPLIFIER BALANCE

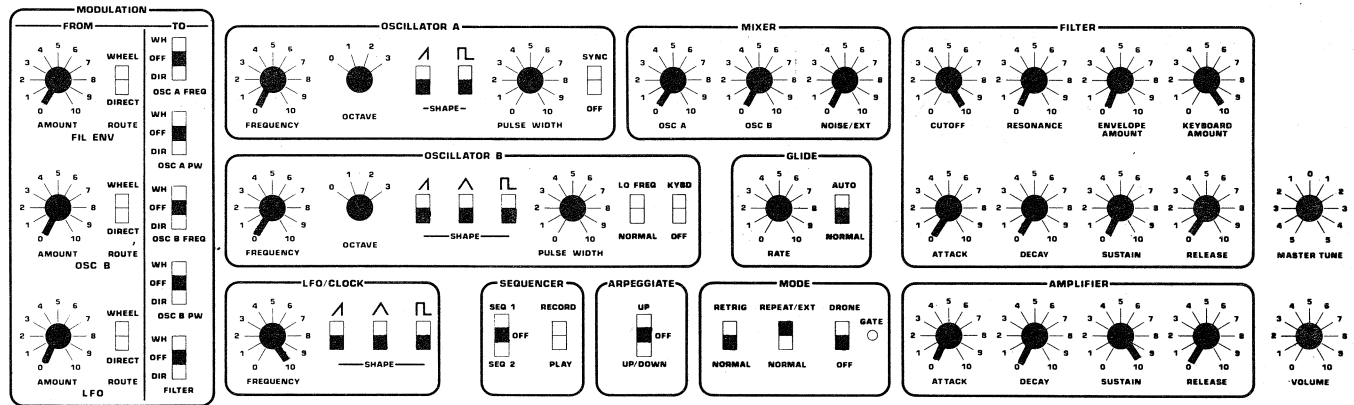

Figure 5-2
AMPLIFIER BALANCE PATCH

1. Patch according to Figure 5-2.
2. Increase system volume to fairly high level. Adjust R1138 VCA BALANCE for minimum envelope bleed-through.

5-5 KEY CONTACTS

After the top panel is removed, the keyboard can be detached from the bottom panel for cleaning by simply removing four screws.

The keyboard uses self-cleaning, gold-plated contacts which will provide many years of reliable service. Oxidation, particularly of lesser-used keys, may be aggravated by ambient conditions or handling. If this occurs, causing "dead" keys, wipe the contacts carefully with an alcohol- or freon-wetted cotton swab. Don't use any abrasive techniques, as this will simply remove the gold plating.

5-6 DIGITAL INTERFACE

Use of the digital interface for external computer control requires both some simple hardware modifications to the Pro-One and the creation of software for your system. If you doubt your technical ability to install the interface, please see an SCI Authorized Service Center or contact our Service Department. However please note that we must leave all questions of programming your system to you. For parts locations, see Figure 5-1.

1. Remove U113 8021 microcomputer from its socket. Keep it safe. Note that with the 8021 removed, the Pro-One's keyboard cannot operate.
2. Jumper pin 2 of the 8021's socket to J101-7. Pads are provided on the printed circuit board (PCB) for this purpose.
3. Add R1182, 10K-ohm, 1/4W, 5% resistor where shown on Figure 5-1.
4. Table 5-0 lists pin assignments. Mate J101 with a 14-wire ribbon cable terminated in a DIP plug.

Table 5-0
DIGITAL INTERFACE PINS (J101)

<u>PIN</u>	<u>SIGNAL</u>	<u>PIN</u>	<u>SIGNAL</u>
1	D5	7	GATE
2	D4	8	DAC EN
3	D3	9-14	GROUND
4	D2		
5	D1		
6	D0		

The interface is compatible with standard TTL logic, where a 0 is signified by less than 0.8V and a 1 by greater than 2.5V. It accepts six data bits (D0 through D5). This allows the numbers 0 through 63 (decimal) to convert to over five octaves of "keyboard" control when latched to the internal digital-to-analog converter (DAC) by the positive-going DAC EN pulse. The GATE is exercised via a bit at pin 7.

5. To play notes on the Pro-One, the system driving it will have to do something like the following. (The way in which these events happen is not so important as their sequence.) At the start, the analog KYBD CV output from the DAC (which controls the oscillators and filter) is unknown. Nothing is now heard from the Pro-One because the envelope generators are not being gated. First the system somehow decides what key (out of 63) it wants to play. It then sets up the key number in binary form on D0-D5. (This might be done with a six-bit output port.) Next DAC EN must be forced high, latching the key data. For practical purposes a delay of 20 microseconds will allow the DAC time to "settle" (worst-case). At this point, GATE can go high, triggering the envelope generators. When the note is to be turned off, it is likewise advisable to turn the GATE off (low) before again strobing the DAC.

6. To return the Pro-One to normal operation, unplug your system from J101, remove R1182, cut the jumper installed in step 3 and carefully re-install U113, 8021.

5-7 AUTHORIZED SERVICE CENTERS

SHULTZ'S SOUND DESIGN
9542 Pollack
Huntington Beach, CA 92646
(714) 964-5044
(213) 339-9419

DAVID ABELL'S PIANOS
8162 Beverly Blvd.
Los Angeles, CA 90048
(213) 651-2060

VALLEY SOUND
1023 N. La Brea
Los Angeles, CA 90038
(213) 851-2434

SPECIALIZED AUDIO SERVICES
2055 Piedmont Rd.
Atlanta, GA 30324
(404) 873-1138

MUSIC DEALER SERVICE
3210 N. Pulaski
Chicago, IL 60641
(312) 282-8171

AAA SWING CITY
601 Illinois at Vandalia
Colinsville, IL 62284
(618) 345-6700

IRC MUSIC
5911 E. 82nd St.
Indianapolis, IN 46218
(317) 849-7965

PROTOTYPES
10449 Metropolitan Ave.
Kensington, MD 20795
(301) 942-1731

RIVERA MUSIC SERVICE
48 Brighton Ave. #11
Allston, MA 02134
(617) 782-6554

TRIPLE S ELECTRONICS
322 Washington St.
Belleville, NJ 07109
(201) 751-0481

PI CORP
13329 Pearl Rd.
Cleveland, OH 44136
(216) 238-0644

TOLEDO MUSIC SERVICE
3522 Upton Ave.
Toledo, OH 43613
(419) 475-9700

THE MUSICIAN'S BENCH
1733 S.E. Morrison St.
Portland, OR 97214
(503) 232-9237

GUITAR CITY STUDIOS
470 N. 1100 West
Centerville, UT 84014
(801) 292-8461

BOZOTRONICS
315 N. 36th St.
Seattle, WA 98103
(206) 633-3666

LONG & MCQUADE
459 W. Bloor St.
Toronto, Ontario, Canada
(416) 964-8006

SECTION 6

SELECTED BIBLIOGRAPHY

Appleton, John and **Perara, Ronald** The Development and Practice of Electronic Music Prentice-Hall, Englewood Cliffs, NJ.

Backus, John The Acoustical Foundations of Music W.W. Norton and Company, New York, NY.

Deutsch, Herbert Synthesis Alfred Publishing, Sherman Oaks, CA.

Ernst, David The Evolution of Electronic Music Schirmer, New York, NY.

Helmholtz, Hermann On the Sensations of Tone Dover Publications, New York, NY.

Strange, Allen Electronic Music William C. Brown Company, Dubuque, IO.

Wells, Thomas and **Vogel, Eric** The Technique of Electronic Music Sterling Swift Publishing, Manchaca, TX.

Contemporary Keyboard Magazine, 20605 Lazaneo, Cupertino, CA 95014

Polyphony Magazine, Box 20305, Oklahoma City, OK 73156

SECTION 7

FACTORY PATCHES

This section contains 20 patches for the Pro-One ranging from instrumental imitations to sound effects. All sounds are created by setting the Pro-One's controls as diagrammed, then fine-tuning knob settings to your taste.

The diagrams are not meant as absolutes but as examples. The patches should serve as starting points for you to create your own sounds. There is no single, ideal trumpet or bass patch, for example, because the synthesized sound must usually be heard in a musical context of rhythm, melody and harmony. The notes played, their speed, your technique, the voicings of ensemble instruments or soloists, even the acoustical characteristics of the room all influence the perception of many of the knob-set parameters such as pulse-width (PW), envelope settings (ATTACK, DECAY, SUSTAIN, RELEASE), and filter cutoff. The art of patching is the ability to make music with the Pro-One. It takes practice.

Thanks to Kevin Kent for assisting with these patches.

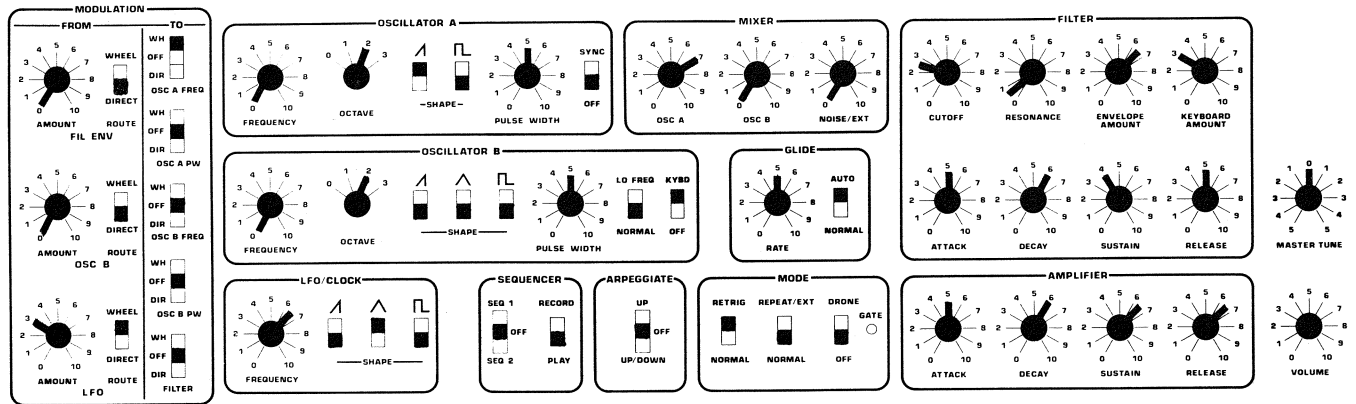

Solo Trumpet

Try auto-glide. Try adding OSC B's sawtooth--raise MIX OSC B. Advancing MOD wheel gives vibrato. Adjust LFO AMOUNT.

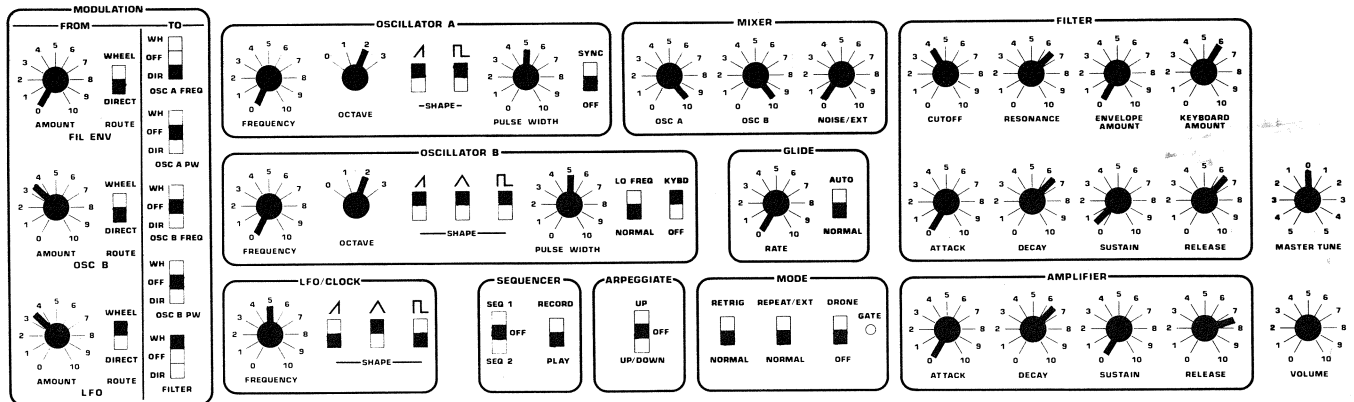

Frequency Modulation Bells

Adjust FILTER RESONANCE and KEYBOARD AMOUNT. MODULATION OSC B AMOUNT sets level of frequency modulation to OSC A.

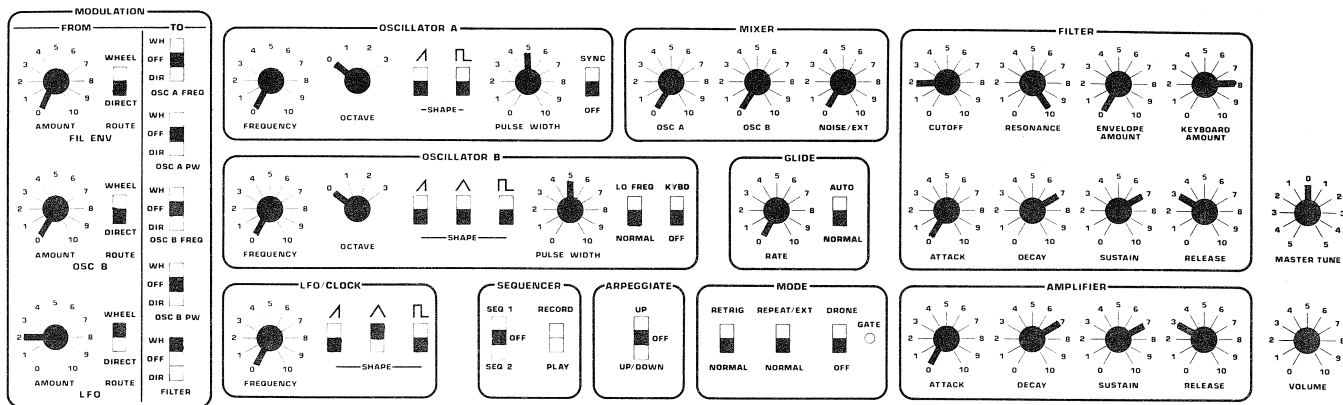

Filter as Oscillator

Tune the filter with FILTER KEYBOARD AMOUNT while playing octaves. CUTOFF controls overall range. Advance MOD wheel. Vary LFO rate. Try reducing AMPLIFIER SUSTAIN and adjusting DECAY level. NORMAL GLIDE with a rate of 6-7 plus wheel-modulation gives 1950s sci-fi film sound. Advance FILTER ENVELOPE AMOUNT.

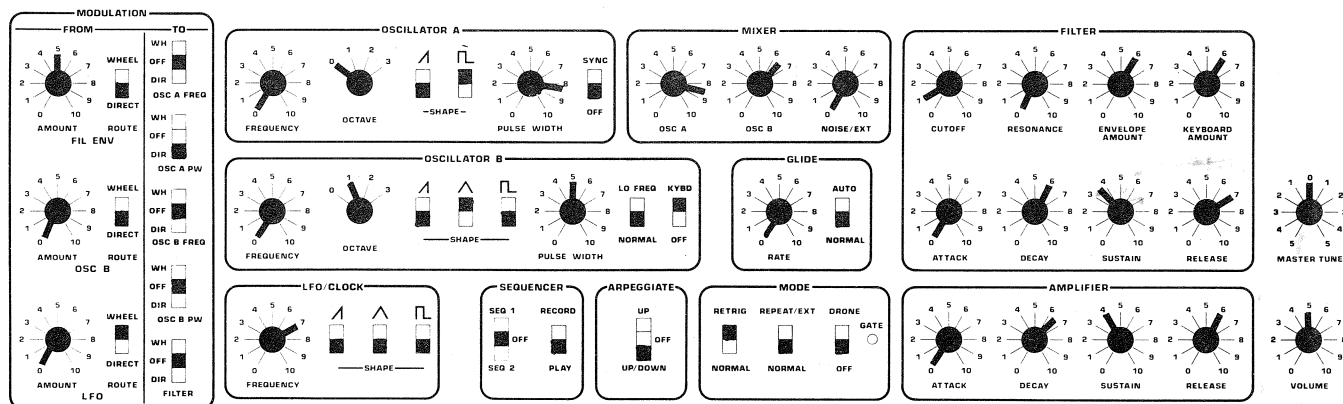

Phunko Basso

Adjust FILTER DECAY, MIX OSC A and MIX OSC B, OSC A PULSE WIDTH, MODULATION FILTER ENVELOPE AMOUNT. Try the SEQUENCER.

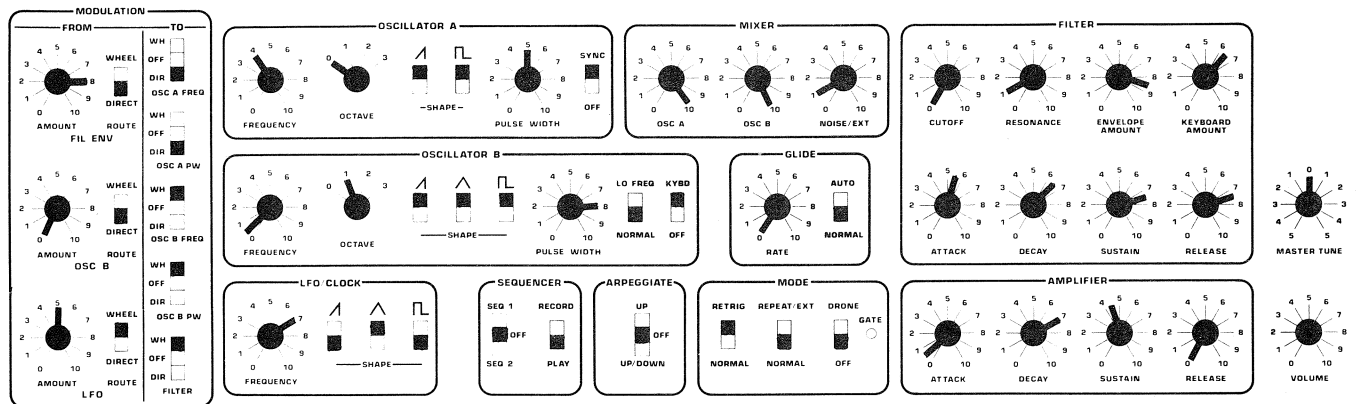

Grunge Guitar

Adjust FILTER ATTACK. It is controlling the sync sweep. Notice there is a little white noise.

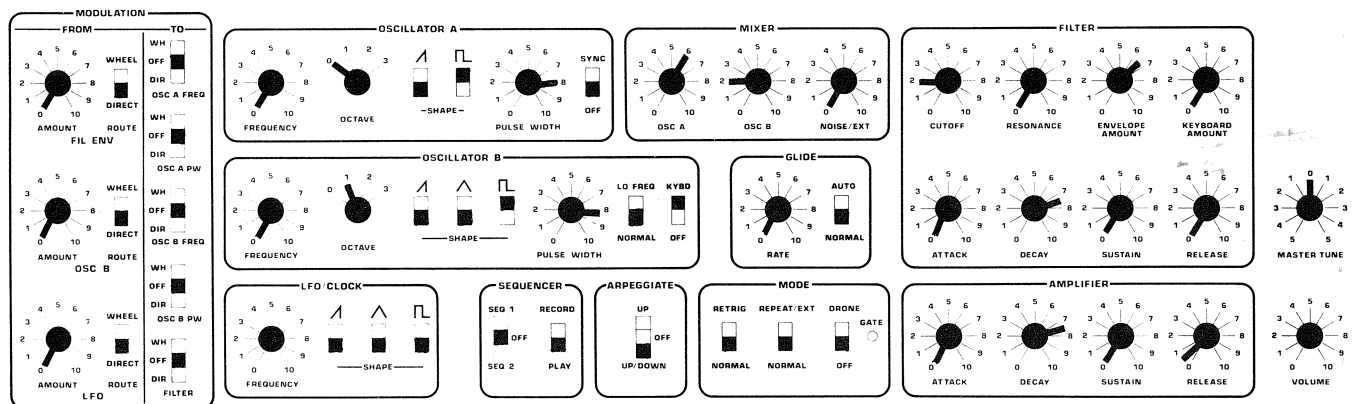

Bass Clav

Trim PULSE WIDTHs near 9. Too far clockwise causes pulse to degenerate to dc (no sound). Raise MIXER OSC B and try different OCTAVES. Adjust DECAY times on both envelopes. Try ARPEGGIATE at fast LFO/CLOCK setting.

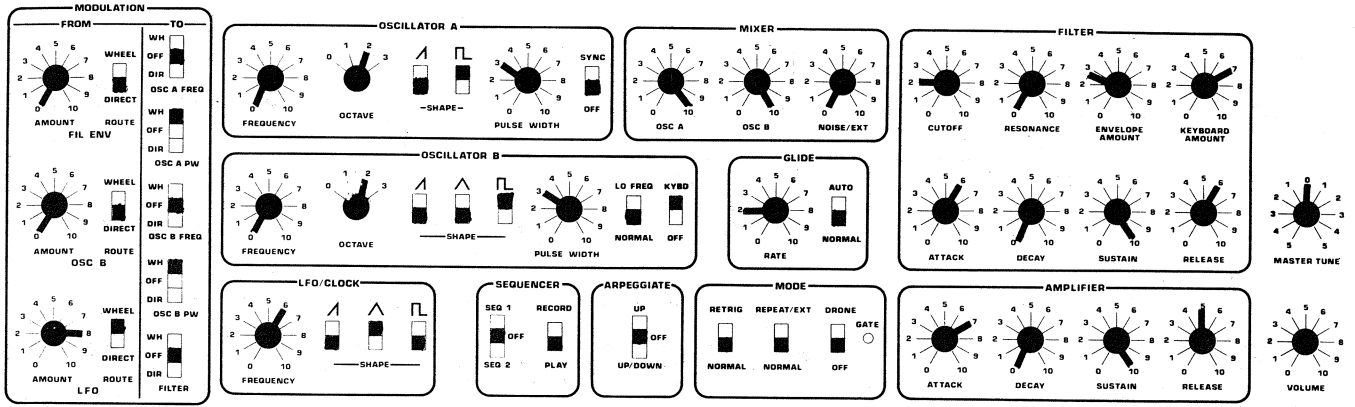

String

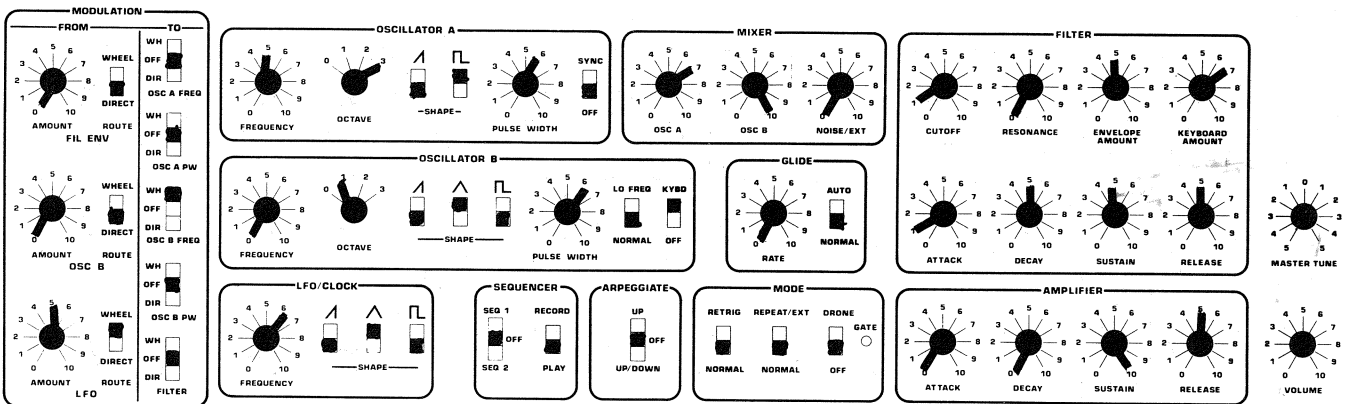

Percussive Organ

Tune OSC A 2 octaves plus a perfect fifth above OSC B. For proper effect, adjust OSC A PULSE WIDTH for square wave by listening for disappearance of the octave overtone. FILTER ENVELOPE AMOUNT adjusts brightness of percussive effect. Mod-wheel provides vibrato.

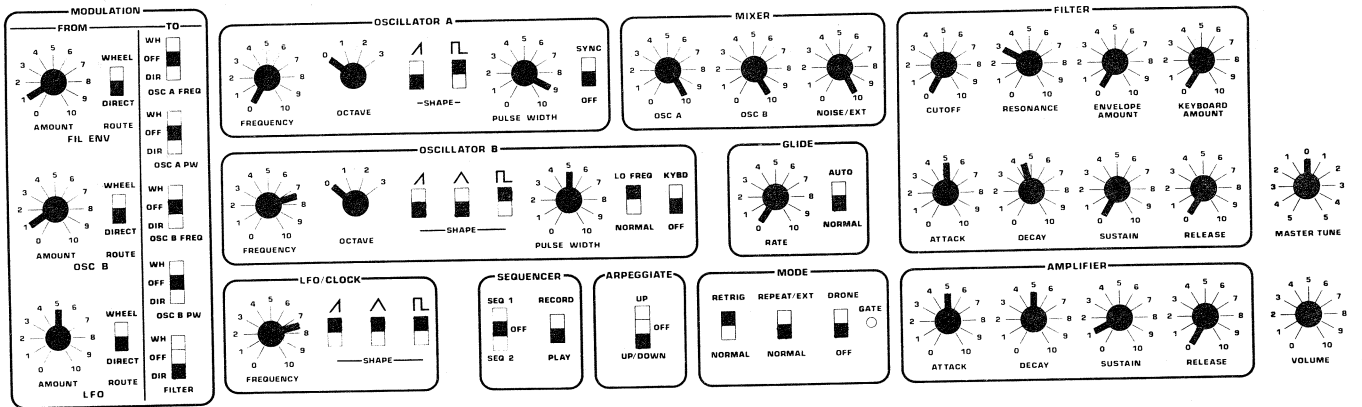

Single-Engine Crop Duster

First hold one key, a second, then add a third or fourth. Latch the arpeggiator or record sequence. Adjust LFO/CLOCK FREQUENCY. Adjust OSC B FREQUENCY, which is secondary LFO. Adjust AMPLIFIER ATTACK and DECAY.

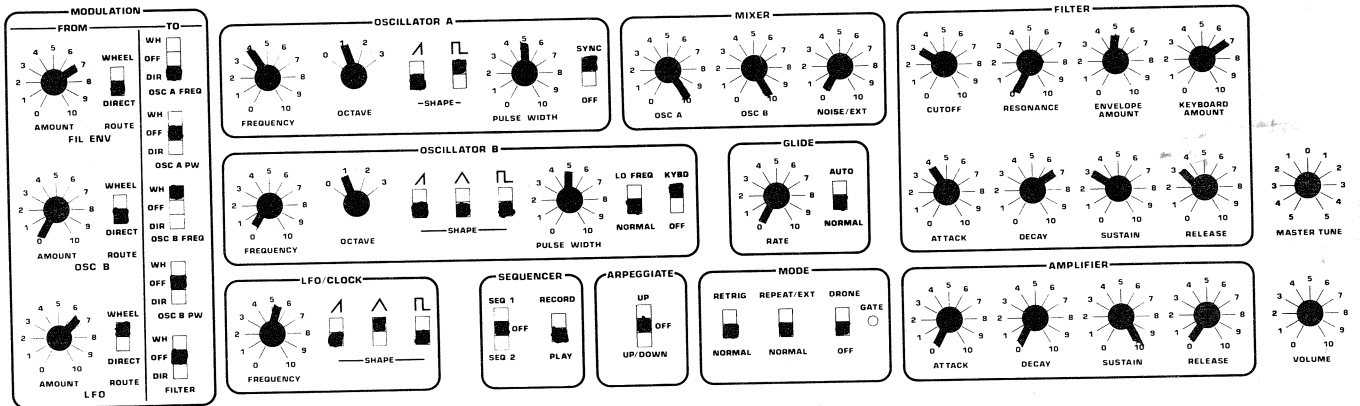

Sync

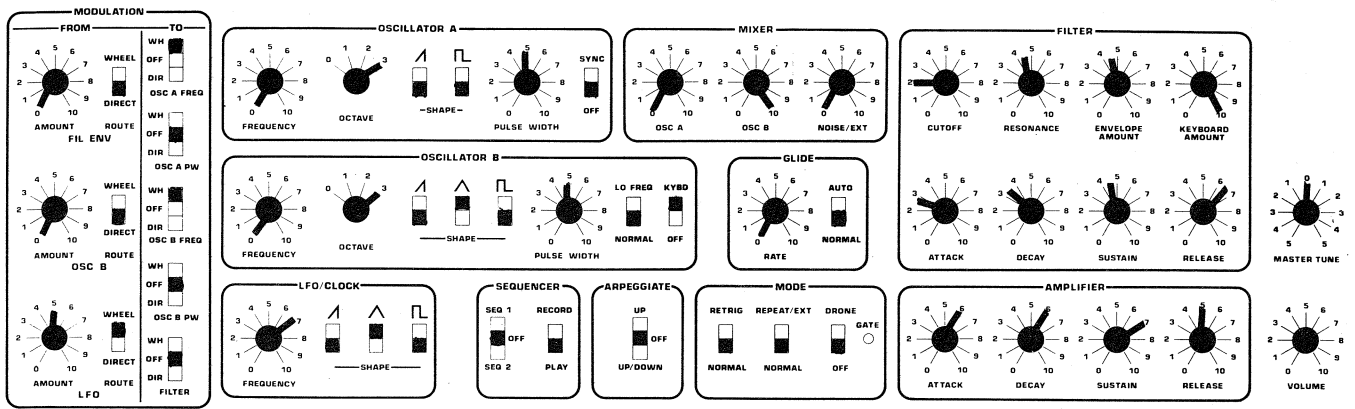

Pipe Organ Flute

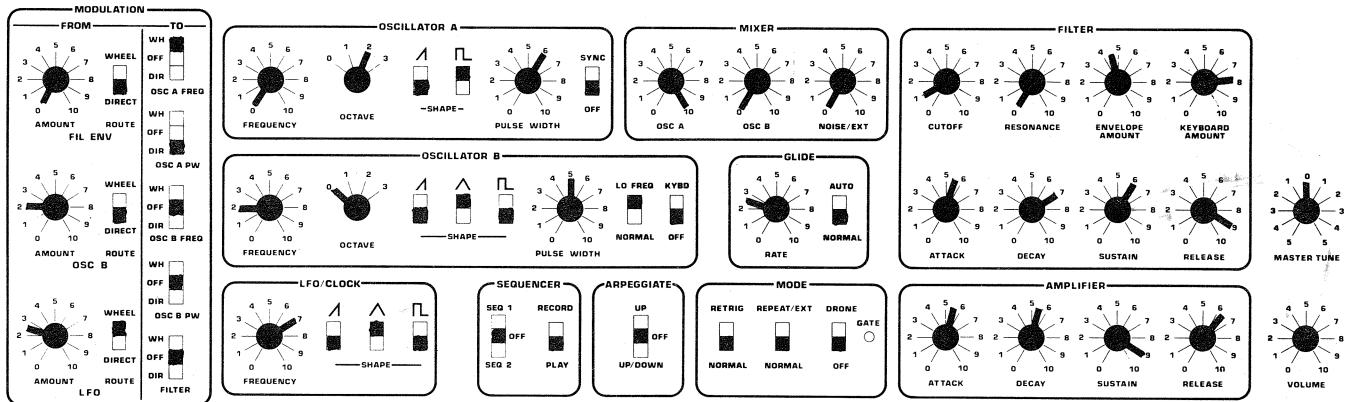

Clarinet

Adjust OSC A PULSE WIDTH for square wave by listening for disappearance of the octave overtone.

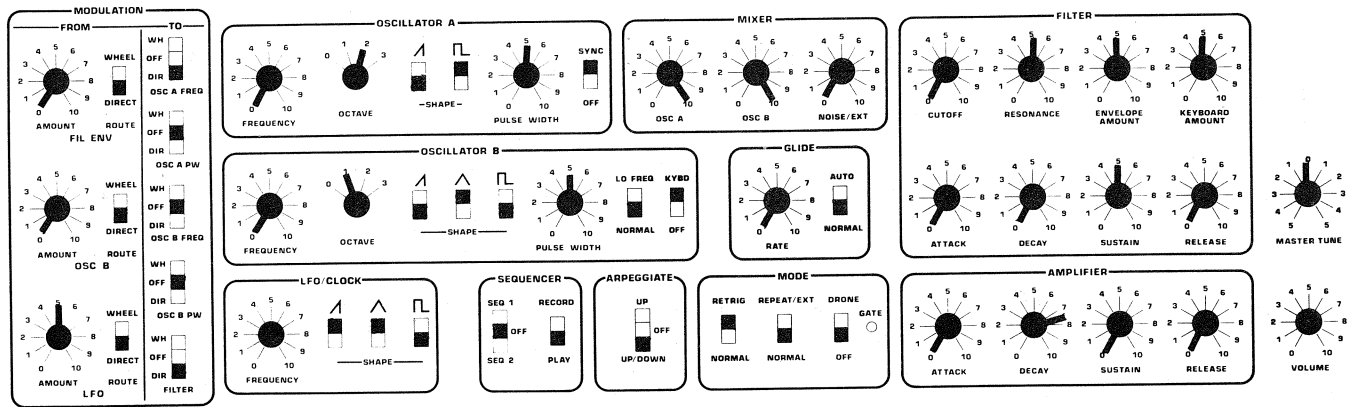

"Delayed" Envelope

Uses LFO as an envelope generator. (LFO is reset by keyboard trigger when ARPEGGIATE is switched on.)

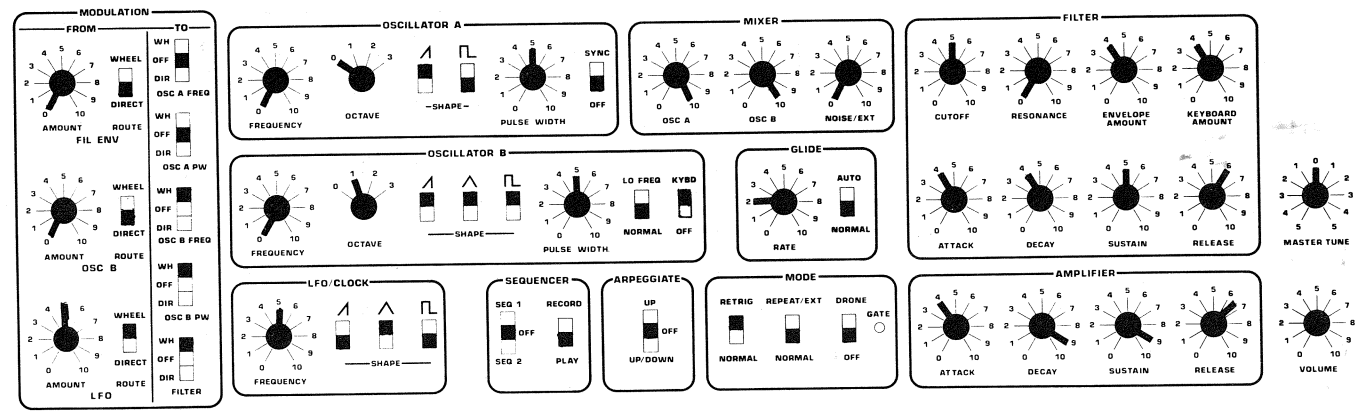

Bass Synth Sustain

Tune OSC A 1 octave below OSC B.

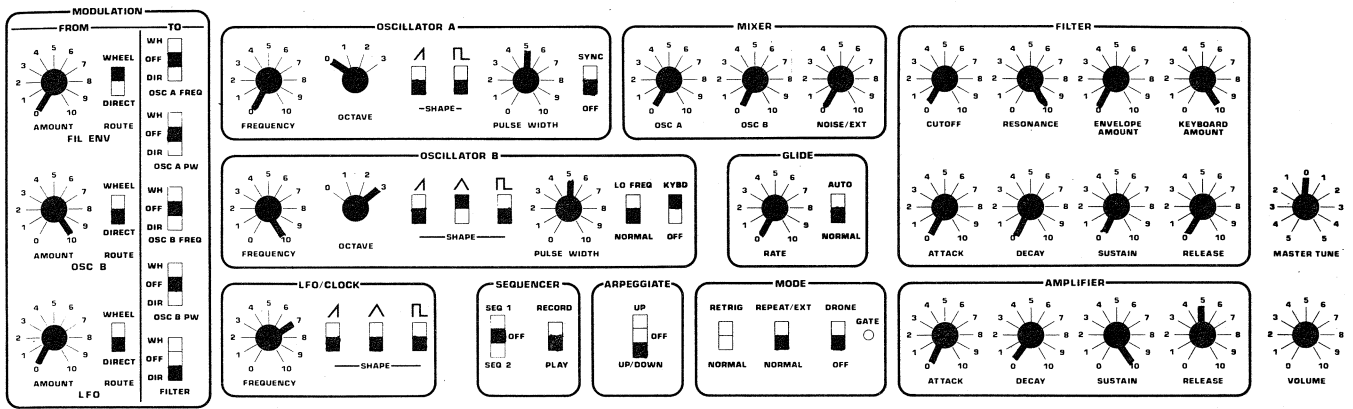

Pseudo Ring Mod Bells

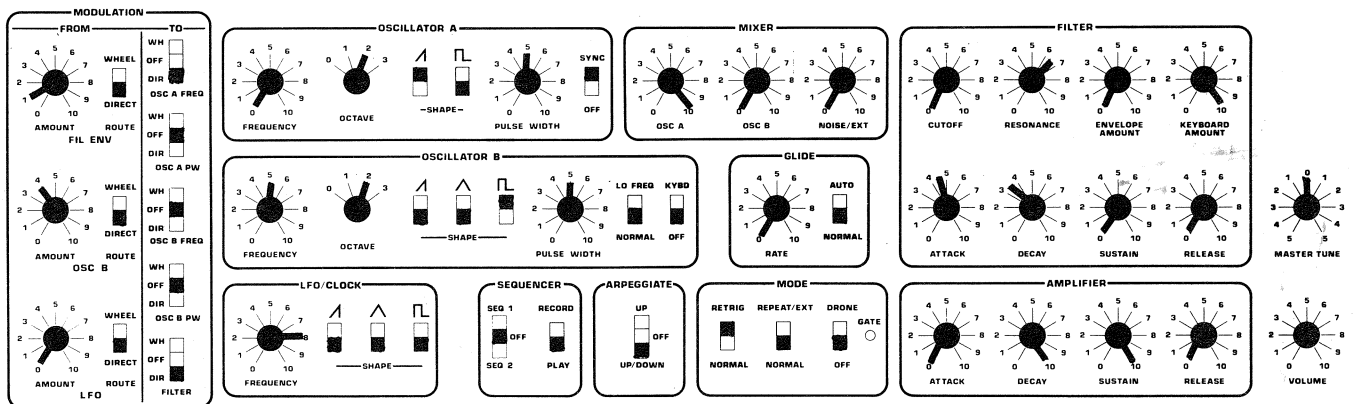

Dynamo

Hold C1, D1, E1, F1, and G1. For variation, switch off OSC B pulse or adjust MODULATION FILTER ENVELOPE AMOUNT. Add keys and latch arpeggiator.

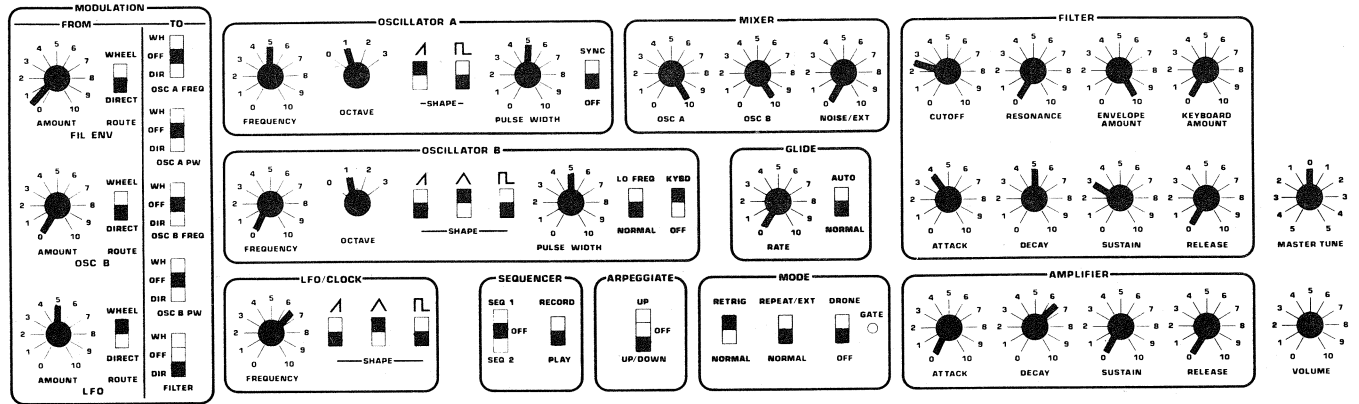

Arpeggiating Fifths

Tune OSC A a perfect fifth above OSC B. Play chords. The LFO/CLOCK is controlling the ARPEGGIATOR and filter modulation through the filter envelope. Change FILTER ENVELOPE AMOUNT and RESONANCE.

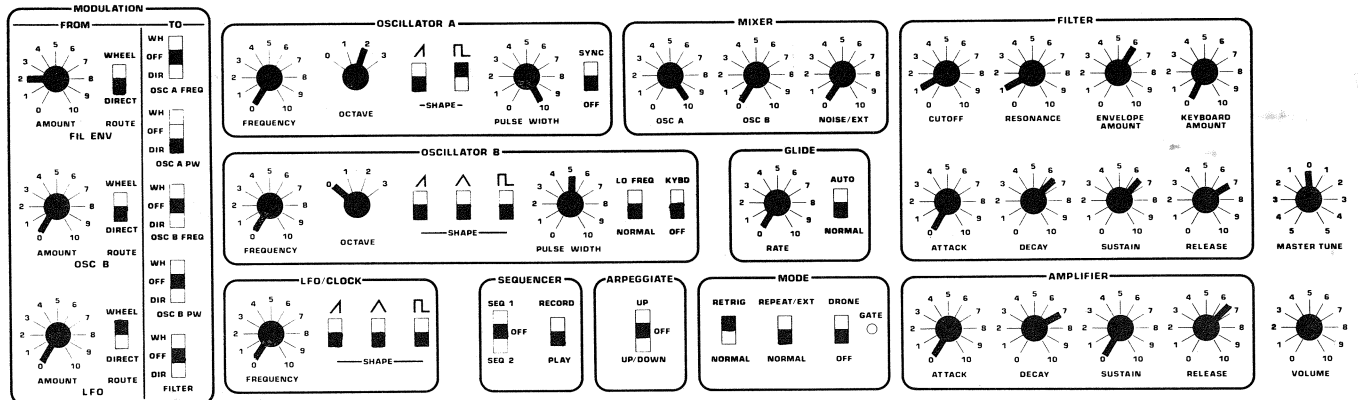

Plucked String

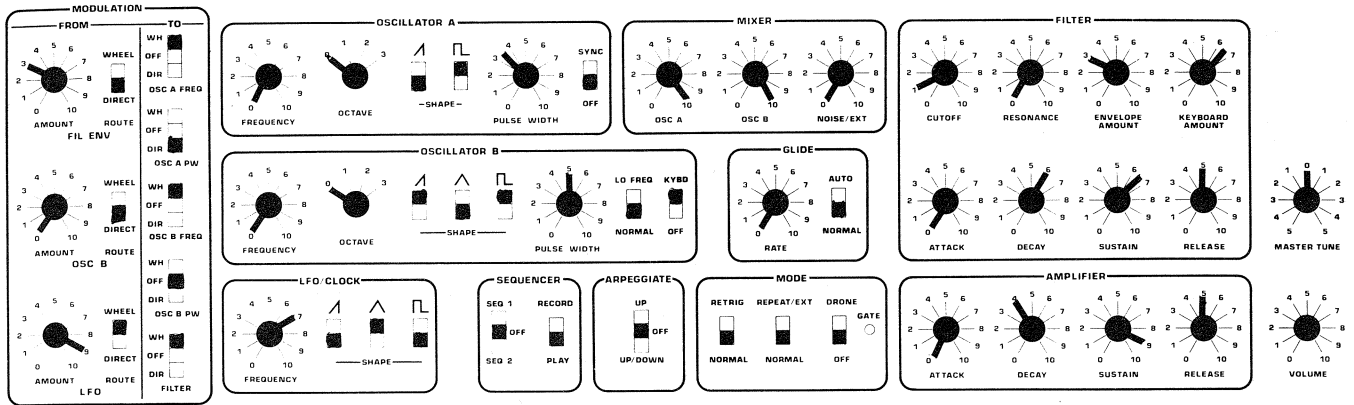

E-Bass

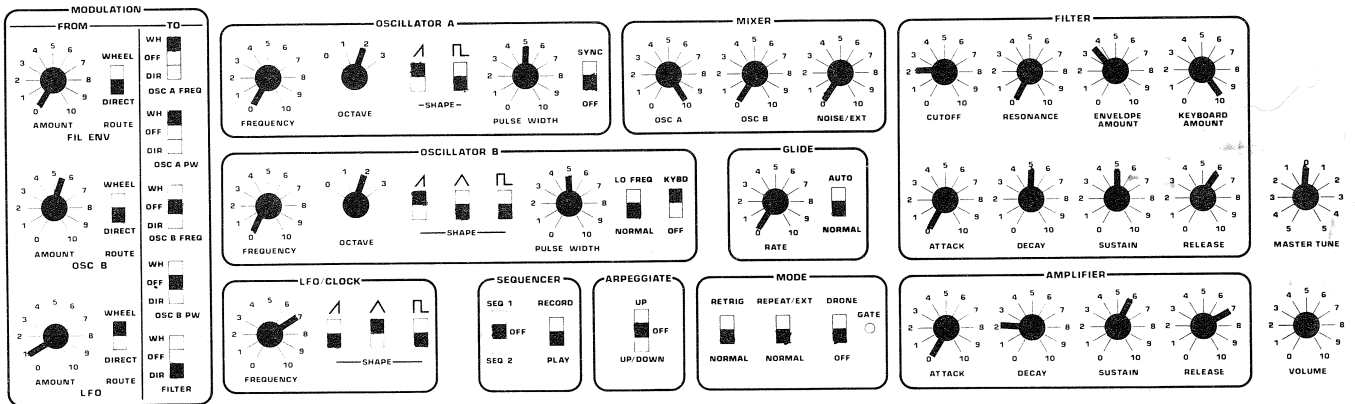

Repeat

SECTION 8

PANEL BLANKS

These panel blanks are provided for you to record your own patches. Feel free to reproduce them for your own use. (For quantities over 100, printing at a "quick print" shop will often be more economical than xerography.)

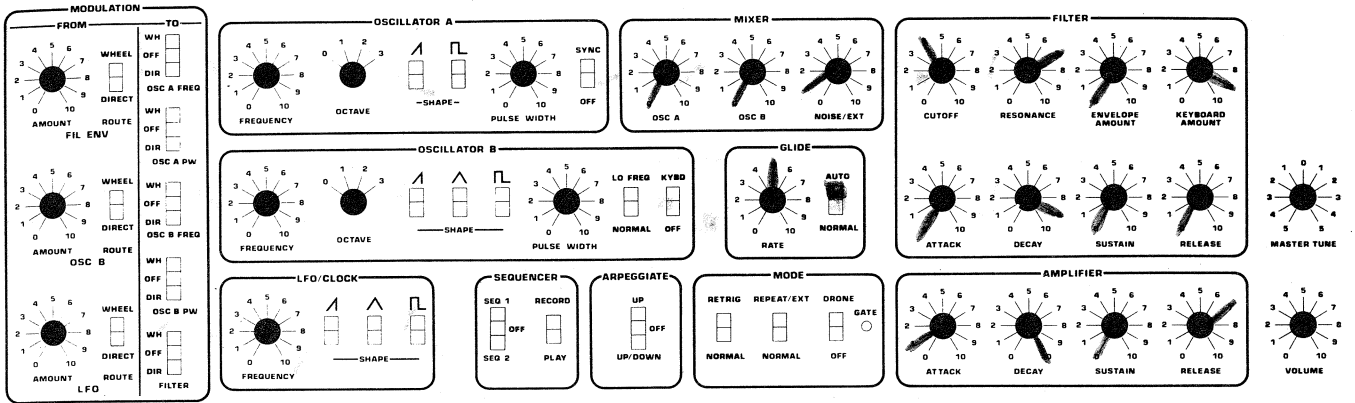

5/3/81 SYNDROM I
 AUTO/GLIDE TRIGGER C3 → C0

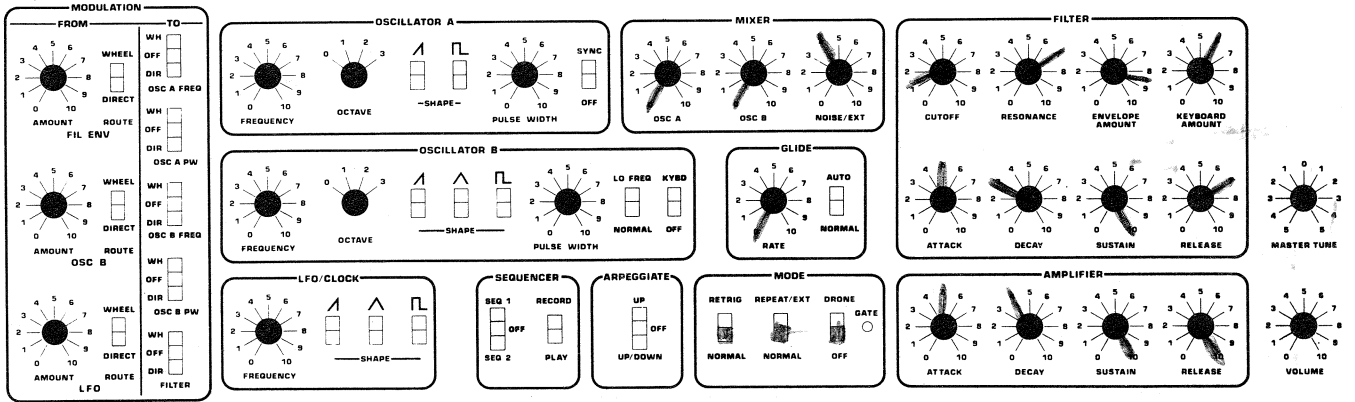

5/3/81 SYNDROM II
 TRIGGER ANY NOTE

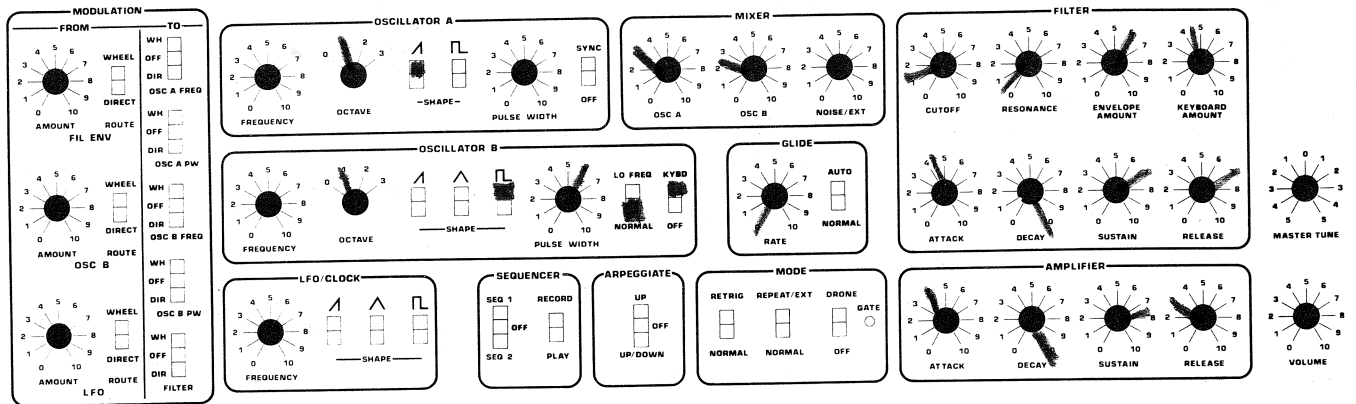

ACCORDIAN

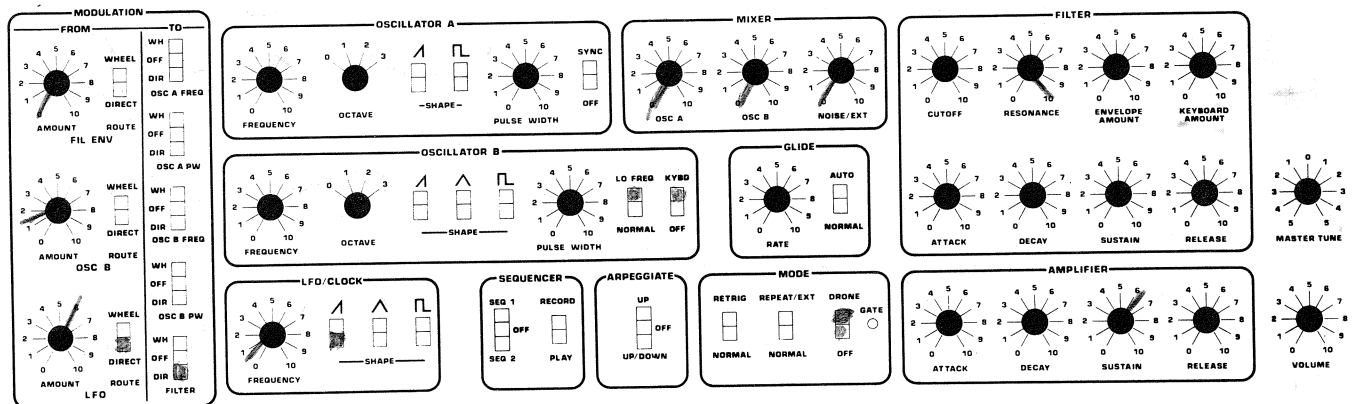

ASCENDING FILTER

SINE WAVE IN LFO CAUSES UP+DOWN PATTERN
 SW LO FREQ/ KYBD CONTRAS
 KYBD ADJUSTS SPA.

MODULATION: FROM (WHEEL, DIR, OSC A FREQ, WH, DIR, OSC B PW, WH, DIR, OSC B FREQ, WH, DIR, OSC B PW, WH, DIR, LFO, ROUTE, FILTER) TO (WH, DIR, OSC A FREQ, WH, DIR, OSC B PW, WH, DIR, OSC B FREQ, WH, DIR, OSC B PW, WH, DIR, LFO, ROUTE, FILTER)

OSCILLATOR A: FREQUENCY, OCTAVE, SHAPE, PULSE WIDTH, SYNC

OSCILLATOR B: FREQUENCY, OCTAVE, SHAPE, PULSE WIDTH, LG FREQ, KYBD, NORMAL, OFF

MIXER: OSC A, OSC B, NOISE/EXT

LFO/CLOCK: FREQUENCY, SHAPE

SEQUENCER: SEQ 1 (RECORD, OFF), SEQ 2 (PLAY, OFF)

ARPEGGIATE: UP, UP/DOWN

MODE: RETRID, REPEAT/EXT, DRONE, GATE, NORMAL, NORMAL, OFF

FILTER: CUTOFF, RESONANCE, ENVELOPE AMOUNT, KEYBOARD AMOUNT

GLIDE: RATE, AUTO, NORMAL

AMPLIFIER: ATTACK, DECAY, SUSTAIN, RELEASE

MASTER TUNE, VOLUME

Slow Ring Mod Filter on Lead Tone Kick

MODULATION: FROM (WHEEL, DIR, OSC A FREQ, WH, DIR, OSC B PW, WH, DIR, OSC B FREQ, WH, DIR, OSC B PW, WH, DIR, LFO, ROUTE, FILTER) TO (WH, DIR, OSC A FREQ, WH, DIR, OSC B PW, WH, DIR, OSC B FREQ, WH, DIR, OSC B PW, WH, DIR, LFO, ROUTE, FILTER)

OSCILLATOR A: FREQUENCY, OCTAVE, SHAPE, PULSE WIDTH, SYNC

OSCILLATOR B: FREQUENCY, OCTAVE, SHAPE, PULSE WIDTH, LG FREQ, KYBD, NORMAL, OFF

MIXER: OSC A, OSC B, NOISE/EXT

LFO/CLOCK: FREQUENCY, SHAPE

SEQUENCER: SEQ 1 (RECORD, OFF), SEQ 2 (PLAY, OFF)

ARPEGGIATE: UP, UP/DOWN

MODE: RETRID, REPEAT/EXT, DRONE, GATE, NORMAL, NORMAL, OFF

FILTER: CUTOFF, RESONANCE, ENVELOPE AMOUNT, KEYBOARD AMOUNT

GLIDE: RATE, AUTO, NORMAL

AMPLIFIER: ATTACK, DECAY, SUSTAIN, RELEASE

MASTER TUNE, VOLUME

88

MAD TRANCE

TMD Sweet Flanger

IN: 100

DIR: 100

EFF: 53

MODULATION

FROM **TO**

WHEEL WH

DIR DIR

OSC A FREQ WH

OFF DIR

DIR OSC A PW WH

OFF DIR

DIR OSC B FREQ WH

OFF DIR

DIR OSC B PW WH

OFF DIR

DIR LFO WH

OFF DIR

DIR FILTER WH

OFF DIR

AMOUNT ROUTE DIR

FIL ENV OSC A DIR

OSC B DIR

LFO DIR

FILTER DIR

OSCILLATOR A

FREQUENCY OCTAVE -SHAPE- PULSE WIDTH SYNC

MIXER

OSC A OSC B NOISE/EXT

FILTER

CUTOFF RESONANCE ENVELOPE AMOUNT KEYBOARD AMOUNT

ATTACK DECAY SUSTAIN RELEASE

OSCILLATOR B

FREQUENCY OCTAVE -SHAPE- PULSE WIDTH LO FREQ KYBD NORMAL OFF

GLIDE

RATE AUTO NORMAL

LFO/CLOCK

FREQUENCY -SHAPE-

SEQUENCER

SEQ 1 RECORD UP OFF

SEQ 2 PLAY UP/DOWN

ARPEGGIATE

UP OFF

UP/DOWN

MODE

RETRIG REPEAT/EXT DRONE GATE

NORMAL NORMAL OFF

AMPLIFIER

ATTACK DECAY SUSTAIN RELEASE

MASTER TUNE

VOLUME

MODULATION

FROM **TO**

WHEEL WH

DIR DIR

OSC A FREQ WH

OFF DIR

DIR OSC A PW WH

OFF DIR

DIR OSC B FREQ WH

OFF DIR

DIR OSC B PW WH

OFF DIR

DIR LFO WH

OFF DIR

DIR FILTER WH

OFF DIR

AMOUNT ROUTE DIR

FIL ENV OSC A DIR

OSC B DIR

LFO DIR

FILTER DIR

OSCILLATOR A

FREQUENCY OCTAVE -SHAPE- PULSE WIDTH SYNC

MIXER

OSC A OSC B NOISE/EXT

FILTER

CUTOFF RESONANCE ENVELOPE AMOUNT KEYBOARD AMOUNT

ATTACK DECAY SUSTAIN RELEASE

OSCILLATOR B

FREQUENCY OCTAVE -SHAPE- PULSE WIDTH LO FREQ KYBD NORMAL OFF

GLIDE

RATE AUTO NORMAL

LFO/CLOCK

FREQUENCY -SHAPE-

SEQUENCER

SEQ 1 RECORD UP OFF

SEQ 2 PLAY UP/DOWN

ARPEGGIATE

UP OFF

UP/DOWN

MODE

RETRIG REPEAT/EXT DRONE GATE

NORMAL NORMAL OFF

AMPLIFIER

ATTACK DECAY SUSTAIN RELEASE

MASTER TUNE

VOLUME

MODULATION

FROM: WHEEL, DIR, AMOUNT, FIL ENV, ROUTE, DIRECT

TO: WH, OFF, DIR, OSC A FREQ, WH, OFF, DIR, OSC A PW, WH, OFF, DIR, OSC B FREQ, WH, OFF, DIR, OSC B PW, WH, OFF, DIR, LFO, WH, OFF, DIR, FILTER

OSCILLATOR A

FREQUENCY, OCTAVE, -SHAPE-, PULSE WIDTH, SYNC, OFF

MIXER

OSC A, OSC B, NOISE/EXT

FILTER

CUTOFF, RESONANCE, ENVELOPE AMOUNT, KEYBOARD AMOUNT

OSCILLATOR B

FREQUENCY, OCTAVE, -SHAPE-, PULSE WIDTH, LO FREQ, KYBD, NORMAL, OFF

GLIDE

RATE, AUTO, NORMAL

LFO/CLOCK

FREQUENCY, -SHAPE-

SEQUENCER

SEQ 1 RECORD, SEQ 2 PLAY, OFF

ARPEGGIATE

UP, DOWN, UP/DOWN, OFF

MODE

RETRIG, REPEAT/EXT, DRONE, GATE, NORMAL, OFF

AMPLIFIER

ATTACK, DECAY, SUSTAIN, RELEASE

MASTER TUNE

VOLUME

MODULATION

FROM: WHEEL, DIR, AMOUNT, FIL ENV, ROUTE, DIRECT

TO: WH, OFF, DIR, OSC A FREQ, WH, OFF, DIR, OSC A PW, WH, OFF, DIR, OSC B FREQ, WH, OFF, DIR, OSC B PW, WH, OFF, DIR, LFO, WH, OFF, DIR, FILTER

OSCILLATOR A

FREQUENCY, OCTAVE, -SHAPE-, PULSE WIDTH, SYNC, OFF

MIXER

OSC A, OSC B, NOISE/EXT

FILTER

CUTOFF, RESONANCE, ENVELOPE AMOUNT, KEYBOARD AMOUNT

OSCILLATOR B

FREQUENCY, OCTAVE, -SHAPE-, PULSE WIDTH, LO FREQ, KYBD, NORMAL, OFF

GLIDE

RATE, AUTO, NORMAL

LFO/CLOCK

FREQUENCY, -SHAPE-

SEQUENCER

SEQ 1 RECORD, SEQ 2 PLAY, OFF

ARPEGGIATE

UP, DOWN, UP/DOWN, OFF

MODE

RETRIG, REPEAT/EXT, DRONE, GATE, NORMAL, OFF

AMPLIFIER

ATTACK, DECAY, SUSTAIN, RELEASE

MASTER TUNE

VOLUME

